

TECHNICAL SERVICES



EXHIBITION, MAY 7 - 9, 2017

Sehr geehrte/r Aussteller/In,

herzlichen Dank für Ihre Teilnahme an der Messe! Wir freuen uns, Ihnen diese Servicemappe überreichen zu können. Sie finden darin wichtige Formulare, um Serviceleistungen und Equipment bestellen zu können. Darüber hinaus bieten wir Ihnen **Messestandarchitektur – kreatives Design** und umfassende **Projektentwicklung mit nur einem Ansprechpartner**. Ob in **Systembauweise** oder als **Individualstand** - wir realisieren Ihren Messeauftritt nach Ihren persönlichen Vorstellungen. Falls Sie spezielle Fragen oder Wünsche haben, bitten wir Sie, sich einfach telefonisch unter **+43 1 72 720 - 6101** an unsere Mitarbeiter zu wenden, die Sie jederzeit gerne beraten und unterstützen.

Wir wünschen einen erfolgreichen Messeauftritt!
Ihr **Expoxx** Team / Projektleiter Martin Moser



E: martin.moser@expoxx.at

T: +43 1 72720 - 6207

F: +43 1 72720 - 6109

Dear Exhibitor,

thank you for your decision to take part at the fair. We take pleasure in giving you this service kit, which is intended to serve you as guide to your tenancy.

*Moreover we offer you **stand architecture – creative design** and comprehensive **project settlement up with only one counterpart**.*

*Whether as a **system construction** method or as an **individual booth** - we realise your fair appearance according to your personal requirements.*

*If you have any special questions or wishes, please do not hesitate to call our staff - call no. **+43 1 72 720 - 6101** - which is looking forward to advise and assist you.*

We wish a successful fair appearance!

*Your **Expoxx** Team /*

Project Manager Martin Moser



INHALTSVERZEICHNIS / REGISTER

01-06 Technischer Service | Technical Service

- 01 Stromversorgung | *Electrical installations*
- 02 Standinstallationen | *Booth installations*
- 03 Beleuchtung | *Lighting*
- 04 Planskizze | *Technical layout*
- 05 Reinigung & Müllentsorgung | *Cleaning & Waste disposal*
- 06 Exhibition Information Manual ACV

07 - 15 Mobiliar | Furniture

- 07 Besprechungstische & Tische | *Meeting tables & Tables*
- 08 Tische & Stehtische | *Tables & Hightables*
- 09 Couchtische & Barhocker | *Couch tables & Barstools*
- 10 | 11 Barhocker & Sessel | *Barstools & Chairs*
- 12 Loungemobiliar | *Loungefurniture*
- 13 | 14 Sitzgruppen | *Seating groups*

15 - 31 Stand Ausstattung | Stand Equipment

- 15 | 16 | 17 Ausstattung | *Equipment*
- 18 | 19 Vitrinen & Pulte | *Showcases & Bars*
- 20 Wände & Türen | *Walls & Doors*
- 21 Blenden & Fächer | *Fascias & Shelves*
- 22 Deckenkonstruktion | *Ceiling Construction*
- 23 Bodenbelag | *Floor covering*
- 24 | 25 | 26 | 27 Grafik & Beschriftung | *Graphics & lettering*
- 28 | 29 Pflanzen | *Plants*
- 30 Zahlungsformular | *Payment form*
- 31 Anfrage Individualstände | *Request for individual stands*









ICNC, May 7 - 9, 2017

Veranstaltungsname / Name of Event	Halle & Standnr. / Hall & Standno.	Standgröße in m ² / Booth size in sqm
Firmenname / Company's name	Straße / Street	
Postleitzahl / Postal Code	Ort / Place	
Ansprechpartner / Responsible person	E-Mail / E-Mail	
Telefon / Phone	Fax / Fax	UID - Nr. / VAT-No. only for EU countries

Bitte unbedingt ausfüllen! / Please fill out!

Deadline: 30th of March, 2017

Power connection

quantity	description	price in	quantity	description	price in €
 pcs	Power connection without meter 1-phasis 230V 2,2 kW incl. power consumption	EUR 212,00	 pcs	Power connection without meter 3x1-phasis 230V 6 kW incl. power consumption	EUR 309,50
 pcs	Power connection without meter 3-phasis 400/230V 10 kW incl. power consumption	EUR 535,50	 pcs	Distributor 10 kW	EUR 108,00
 pcs	Power connection without meter 3-phasis 400/230V 20 kW incl. power consumption	EUR 749,00	 pcs	Distributor up to 20 kW	EUR 194,00
 pcs	Power connection without meter 3-phasis 400/230V 40 kW incl. power consumption	EUR 1.207,00	 pcs	Distributor up to 40 kW	EUR 239,50

Obligatory electricity service fee will be charged as following:

<input type="checkbox"/> up to 20 m ²	EUR 40,70
<input type="checkbox"/> 21-70 m ²	EUR 67,20
<input type="checkbox"/> more than 70 m ²	EUR 93,00

Preise pro Verrechnungseinheit auf Messedauer exklusive gesetzlicher Steuern und Abgaben.
Prices per unit for the whole duration of the event excluding taxes and fees, which are legally in force at the time of the event.

Alle Preise verstehen sich für eine Messedauer bis zu 7 Tagen sowie exkl. MWSt. und 1 % Bestandvertragsgebühr. Preisänderungen bleiben vorbehalten.
All prices are quoted for a period of up to seven days and are quoted exclusive VAT and 1% legal charges. Subject to alteration of prices.



WICHTIG - BESTELLFRIST: Bei Bestellungen nach der Bestellfrist muss ein Manipulationszuschlag von 25% verrechnet werden!
IMPORTANT - ORDER DEADLINE: For orders received after the deadline a manipulation surcharge of 25% will be charged!

Durch seine Unterschrift bestätigt der Auftraggeber unsere allgemeine Geschäftsbedingungen (abgedruckt am Ende dieses technischen Bestellheftes) zur Kenntnis genommen zu haben und deren Inhalt als verbindlich zu akzeptieren. Erfüllungsort und Gerichtsstand ist Wien.

By signing this document the customer acknowledges our general terms and conditions (printed on the last page of this technical order form) as noted and accepts it as binding. Place of jurisdiction is Vienna.

Retour/return to:

Expoxx Messebau GmbH | 1021 Wien | Messeplatz 1
☎ FAX +43 1 72 720 - 6109 ☎ info@expoxx.at

 **DATUM**
DATE

Ort, Datum
Place, date

 **STEMPEL**
STAMP

Firmenstempel und rechtsverbindliche Unterschrift
Stamp and obligatory signature

Ausstellerstromversorgung

Sämtliche Elektroarbeiten, welche Sie laut Serviceblatt Stromversorgung bestellen, werden vom Vertragselektriker des Veranstalters durchgeführt und von der Expoxx Messebau GmbH in Rechnung gestellt.

Um ausreichende Betriebssicherheit zu gewährleisten, kann die Einschaltung der Kojenstromkreise erst am Tag vor Messebeginn erfolgen.

Damit Sie Ihre bestellten Stromanschlüsse an der Stelle am Stand vorfinden, wo dieser benötigt wird, senden Sie uns bitte die ausgefüllte Planskizze.

Für den Stromanschluss ist ein Strompaket erforderlich. Bestellen Sie auf Serviceblatt jenen Stromanschluss (=Gesamtwert Ihrer Anschlüsse z.B. Geräte, Beleuchtung udgl.), welchen Sie für Ihren Messestand benötigen.

Für die Stromabrechnung „pauschaliert bis 6 kW“ ist der tatsächliche Anschlusswert maßgebend, welcher während der Veranstaltung durch den Inspektionselektriker festgestellt wurde.

Die Kojenstromversorgung wird 1 Stunde nach Messeschluss aus Sicherheitsgründen eingestellt. Falls Sie eine Stromversorgung für die gesamte Messedauer (Tag und Nacht) benötigen (z.B. für Computer, Kühlvittrinen udgl.), vergessen Sie bitte nicht, einen Dauerstromanschluss zu bestellen.

Elektro-Standinstallationen

Für die Standausstattung benötigte Elektroinstallationen können Sie direkt der Expoxx Messebau GmbH in Auftrag geben oder einer konzessionierten Elektrofirma Ihrer Wahl übertragen, welche über die elektrische Anlage einschließlich der Anschlüsse einen **Elektrobefund (VD 390)**, **spätestens am letzten Aufbautag** entweder beim zuständigen Hallenmeister oder in der Betriebstechnik abzugeben hat (siehe Hausordnung).

Sämtliche Elektroinstallationen müssen den geltenden behördlichen Vorschriften entsprechen und unterliegen einer behördlichen Überprüfung anlässlich der jeweiligen Messekollaudierung (MA 36).

Connection to the electricity network

All power services which you order with service form *power supply* will be performed by the organisers' contract electrician: and invoiced by Expoxx Messebau GmbH.

For safety reasons, stand wiring circuits cannot be switched on until the day before the start of the event.

Please make a sketch of the ordered power connections on service sheet *technical layout* to ensure that you will find the taps at the place needed.

You need a power package for power connection. Please use the order form to inform us of the type of connection required (=total load of your connections e.g. electrical devices, lightning etc.).

In the case of power charged at flat rates up to 6 kW the cost is determined by the actual installed load which is recorded by the inspecting electrician in the course of the event.

The stand power supply is discontinued 1 hour after the end of the event day for safety reasons. Please do not forget to order separate continuous power connections for refrigerators, cold display cabinets, computers, etc.

Electrical installation work:

*You can order the electrical installation work either from our contract electricians or from a licensed electrical firm of your choice, which must submit a **report on the electrical wiring installed („Elektrobefund VD 390“)**, including the connections, to the hall manager at least on the last assembly day (see House Rules & Regulations).*

All electrical installations must meet the legal regulations and will be examined by the authorities involved (MA 36).GmbH.













ICNC, May 7 - 9, 2017

Veranstaltungsname / Name of Event	Halle & Standnr. / Hall & Standno.	Standgröße in m ² / Booth size in sqm
Firmenname / Company's name	Straße / Street	
Postleitzahl / Postal Code	Ort / Place	
Ansprechpartner / Responsible person	E-Mail / E-Mail	
Telefon / Phone	Fax / Fax	UID - Nr. / VAT-No. only for EU countries

Bitte unbedingt ausfüllen! / Please fill out!

Deadline: 30th of March, 2017

**Standinstallation - Beleuchtung (wichtig - ohne Elektrohauptanschluß)
Booth Installations - Lighting (important - without main electric connection)**

	Strahler Standard Spotlight Standard € 35,00 Anschlusswert 120 W / 230 V Connection value 120 W / 230 V		Stromschiene 1 f m inkl. 2 Strahler "Halojet" Electricity rail 1 m incl. 2 spots "Halojet" € 77,50 Anschlusswert 100 W / 230 V / 12 V, silber Connection value 100 W / 230 V / 12 V, silver
	Auslegestrahler Standard, Halogen, chrom Extention arm spotlight, halogen, chrome € 54,50 Anschlusswert 100 W / 230 V Connection value 100 W / 230 V		Stromschiene 1 f m inkl. 2 Hängeleuchten "Halopin" Electricity rail 1 m incl. 2 hanging lamps "Halopin" € 89,00 Anschlusswert 80 W / 230 V Connection value 80 W / 230 V
	Auslegestrahler "Nova", silber Extention arm spotlight "Nova", silver € 91,10 Anschlusswert 300 W / 230 V Connection value 300 W / 230 V		Stromschiene 1 f m inkl. 1 Bühnenstrahler, silber Electricity rail 1 m incl. 1 stage spot, silver € 98,00 Anschlusswert 70 W / 230 V Connection value 70 W / 230 V
	Einbaustrahler Decke, Halogen, silber Fitted ceiling spotlight, halogen, silver € 38,10 Anschlusswert 50 W / 230 V Connection value 50 W / 230 V		Bühnenstrahler, silber ☒ Stage spot, silver € 101,20 Anschlusswert 1000 W / 230 V Connection value 1000 W / 230 V
	Stromschiene 1 f m inkl. 2 Strahler "Concord" Electricity rail 1 m incl. 2 spots "Concord" € 77,50 Anschlusswert 200 W / 230 V Connection value 200 W / 230 V		Strahler Halogen, silber * Halogen spotlight, silver € 86,50 Anschlusswert 300 W / 230 V Connection value 300 W / 230 V
	Stromschiene 1 f m inkl. 1 Strahler "Ellipsoid" Electricity rail 1 m incl. 1 spot "Ellipsoid" € 101,50 Anschlusswert 70 W / 230 V, eloxal Connection value 70 W / 230 V, eloxal		Deckenfluter silber ☒ uplights silver € 252,30 Anschlusswert 400 W / 230 V Connection value 400 W / 230 V
	Stromschiene 1 f m inkl. 1 Strahler "Powerspot" Electricity rail 1 m incl. 1 spot "Powerspot" € 106,50 Anschlusswert 150 W / 230 V, silber Connection value 150 W / 230 V, silver		

- ★ erhältlich nur für Montage am Messestand! / Only for assembly at the fair-booth!
 - ☒ Nur in Verbindung mit Trägersystem auf Anfrage. / Only in connection with a carryin-system on request.
 - ☒ nur in Verbindung mit Rasterdecke und Einlegeplatte mit Ausschnitt! / Only with ceiling grid and fitting panel!
- Stromversorgung erfolgt über die Bodenauslässe. / Power is supplied through the floor outlets.

Die Preise verstehen sich für die betriebsfertige Montage, Miete für Material u. Beleuchtungskörper sowie Demontage. Um eine ausreichende Stromversorgung Ihres Messestandes zu gewährleisten, ist es unbedingt erforderlich, dass Sie die genauen Anschlußwerte bekanntgeben! All prices include installation, rental fees for material and lightening fixtures and dismantling. To provide sufficient power supply for your booth, it is required that you notify the exact connected loads.

Alle Preise verstehen sich für eine Messedauer bis zu 7 Tagen sowie exkl. MWSt. und 1 % Bestandvertragsgebühr. Preisänderungen bleiben vorbehalten. All prices are quoted for a period of up to seven days and are quoted exclusive VAT and 1% legal charges. Subject to alteration of prices.

! WICHTIG - BESTELLFRIST: Bei Bestellungen nach der Bestellfrist muss ein Manipulationszuschlag von 25% verrechnet werden!
IMPORTANT - ORDER DEADLINE: For orders received after the deadline a manipulation surcharge of 25% will be charged!

Durch seine Unterschrift bestätigt der Auftraggeber unsere allgemeine Geschäftsbedingungen (abgedruckt am Ende dieses technischen Bestellheftes) zur Kenntnis genommen zu haben und deren Inhalt als verbindlich zu akzeptieren. Erfüllungsort und Gerichtsstand ist Wien.

By signing this document the customer acknowledges our general terms and conditions (printed on the last page of this technical order form) as noted and accepts it as binding. Place of jurisdiction is Vienna.

Retour/return to:

Expoxx Messebau GmbH | 1021 Wien | Messeplatz 1
☎ FAX +43 1 72 720 - 6109 ☎ info@expoxx.at

 **DATUM**
DATE

 **STEMPEL**
STAMP

Ort, Datum
Place, date

Firmenstempel und rechtsverbindliche Unterschrift
Stamp and obligatory signature

ICNC, May 7 - 9, 2017

Veranstaltungsname / Name of Event	Halle & Standnr. / Hall & Standno.	Standgröße in m ² / Booth size in sqm
Firmenname / Company's name	Straße / Street	
Postleitzahl / Postal Code	Ort / Place	
Ansprechpartner / Responsible person	E-Mail / E-Mail	
Telefon / Phone	Fax / Fax	UID - Nr. / VAT-No. only for EU countries

Bitte unbedingt ausfüllen! / Please fill out!

Deadline: 30th of March, 2017

Standreinigung / Stand cleaning

Menge quantity	Bezeichnung description	Preis in € price in
Grundreinigung / basic cleaning		
<input type="text"/>	einmalig vor Messebeginn / one time before the event (gereinigt werden Messestand, Fussboden & Mobiliar - ausgenommen Exponate) / (booth, floor & furniture will be cleaned - except exponates)	EUR 2,30
m ² /sqm		
Standreinigung / stand cleaning		
<input type="text"/>	Grundreinigung (wie o.a.) und tägl. Reinigung nach Messeschluß / Basic Cleaning and daily cleaning after end of fair (Tische feucht abwischen, Papierkörbe entleeren, Hartbodenbeläge nass wischen, Teppich saugen) / (tables will be wiped, bins emptied, hard flooring wiped wet, carpet vacuumed)	EUR 3,40
m ² /sqm		

Müllentsorgungsauftrag / Waste disposal order

während Aufbau / during setup

während Abbau / during dismantling time

Menge quantity	Bezeichnung description	Preis in € price in €	Menge quantity	Bezeichnung description	Preis in € price in €
<input type="text"/>	Müllentsorgung Mischmüll Waste disposal bulky waste / mixed waste (z.B. nicht sortierte Spanplattenreste, Metall- und Holzreste, Plastik etc./ eg. non-sorted chipboards, metal and wood off cuts, plastics, etc.)	EUR 145,50	<input type="text"/>	Müllentsorgung Mischmüll Waste disposal bulky waste / mixed waste (z.B. nicht sortierte Spanplattenreste, Metall- und Holzreste, Plastik etc./ eg. non-sorted chipboards, metal and wood off cuts, plastics, etc.)	EUR 145,50
m ³			m ³		

Alle Preise verstehen sich für eine Messedauer bis zu 7 Tagen sowie exkl. MWSt. und 1 % Bestandvertragsgebühr. Preisänderungen bleiben vorbehalten.
All prices are quoted for a period of up to seven days and are quoted exclusive VAT and 1% legal charges. Subject to alteration of prices.



WICHTIG - BESTELLFRIST: Bei Bestellungen nach der Bestellfrist muss ein Manipulationszuschlag von 25% verrechnet werden!
IMPORTANT - ORDER DEADLINE: For orders received after the deadline a manipulation surcharge of 25% will be charged!

Durch seine Unterschrift bestätigt der Auftraggeber unsere allgemeine Geschäftsbedingungen (abgedruckt am Ende dieses technischen Bestellheftes) zur Kenntnis genommen zu haben und deren Inhalt als verbindlich zu akzeptieren. Erfüllungsort und Gerichtsstand ist Wien.

By signing this document the customer acknowledges our general terms and conditions (printed on the last page of this technical order form) as noted and accepts it as binding. Place of jurisdiction is Vienna.

Retour/return to:

Expoxx Messebau GmbH | 1021 Wien | Messeplatz 1
☎ FAX +43 1 72 720 - 6109 ☎ info@expoxx.at

 DATUM
DATE

Ort, Datum
Place, date

 STEMPEL
STAMP

Firmenstempel und rechtsverbindliche Unterschrift
Stamp and obligatory signature

Austria Center Vienna exhibition manual

Conference venue

Austria Center Vienna
Bruno-Kreisky-Platz 1
1220 Vienna, Austria

Conference venue web site <https://www.acv.at/index.en.html>

Austria Center Vienna is part of the Internationales Amtssitz- und Konferenzzentrum Wien Aktiengesellschaft (IAKW-AG). The Austria Center Vienna is Austria's largest conference centre, with 24 halls, 180 meeting rooms and some 22,000 square metres of exhibition space, and is one of the top players on the international conference circuit.

Technical guidelines and general information

The following technical guidelines shall only apply where the Contractual Partner has hired rooms and facilities for exhibition purposes. An exhibitor in the meaning of these technical guidelines shall mean every exhibitor who is active on the premises of Austria Center Vienna by reason of the event described in the Agreement Concerning the Event. Where the exhibitor is not the Contractual Partner, the Contractual Partner is obliged to require each exhibitor to comply with these technical guidelines and ensure compliance. The Contractual Partner shall, in particular, ensure that these technical guidelines are complied with in practice, and shall be liable to Austria Center Vienna for any damages arising from non-compliance.

Deliveries, in-house transportation and shipping instructions

Transport of stand construction materials and exhibits to and from the premises

- The exhibitor is responsible for the transportation of exhibits and any stand construction materials to and from the premises at its own expense and risk. Deliveries must arrive shortly before scheduled unloading, and must depart promptly after loading. If exhibition material is delivered by the exhibitor's own freight forwarding partner, the freight forwarder must contact IML upon arrival at Austria Center Vienna, as in-house delivery is generally handled by IML.
- If the exhibitor is working with IML, companies delivering materials will be directly advised by them. If delivery is arranged by the exhibitor or by the exhibitor's exhibition stand builder themselves, the official set-up time for the event must be observed. The following access route should be used:

After entering the "Leonard-Bernstein-Strasse" tunnel, do not take the first illuminated exit on the right to "Austria Center Vienna". Continue to the end of the tunnel and turn right at the sign for "Saturn Tower". You will then come to a goods vehicle parking area and the sign for the IML office (Tor 1/Gate 1).

- Delivery is possible via the IML delivery entrance (Tor 1/Gate 1) and must be announced in advance.
- In exceptional cases, delivery is also possible via the delivery entrance (Tor 4/Gate 4) on the other side of the building (height limit of 4m). Please request access for delivery with the according project manager of Austria Center Vienna through the congress organiser and respect the clearway around this entrance.
- Night-time noise regulations: with regard to the use of Exhibition Halls X1, X2, X3 and X4, attention is expressly drawn to the need for the Contractual Partner to comply strictly with the night-time noise regulations. Noise restrictions generally apply between 10 p.m. and 6 a.m. and on Sundays

and public holidays. Restrictions on the movement of goods vehicles apply on Saturdays between 3 p.m. and midnight and on Sundays and public holidays between midnight and 10 p.m.

- Vehicles may only use the access ramp to Bruno-Kreisky-Platz one at a time and with a gross vehicle weight of under 25 tonnes
- Austrian traffic regulations must be observed. It is forbidden to leave engines running. Exhibitors shall not be entitled to compensation for any waiting times. Goods vehicles may only be parked on Austria Center Vienna's premises in exceptional cases, and with the written permission of Austria Center Vienna. Instructions given by Austria Center Vienna must be followed at all times.
- Freight elevators are located at Gate 1 and Gate 4 to deliver the goods to the correct level. IML should be contacted if forklift rental is required and for any other in-house transportation services, as well as for storage of empty crates.

Use of goods-only lifts

Exhibition materials may be brought into the Austria Center Vienna building using four goods lifts, each with a maximum payload of 3,000kg. Two goods lifts allow delivery of materials directly to Hall X4 from the goods vehicle parking area. Materials are brought into Halls X1, X2 and X3 at street level. Goods lifts may not be used to transport people. Instructions given by Austria Center Vienna staff must be followed at all times. Austria Center Vienna accepts no liability in the event of any contravention of these regulations. The **freight elevators** inside the Austria Center Vienna and in the exhibition halls can only be operated from outside, with a key. Freight needs to be stored and secured within the yellow lines in the elevator. The elevator must be called from the level to which the freight needs to be delivered. All freight elevators have the following dimensions: 6.20m (length) x 3.20m (width) x 3.10m (height).

Use of passenger lifts and escalators

Passenger lifts and escalators may not be used to transport goods or equipment.

Storage of empties

Empties should generally be stored directly with IML, an external partner of Austria Center Vienna. In exceptional circumstances Austria Center Vienna will allocate storage space, for which a fee will be charged.

Vehicles and forklifts are not allowed inside exhibition areas. Only forklift trucks operated by IML are permitted within the loading bay. Only pallet jacks and trolleys are permitted in the exhibition areas.

Halls X1, X2 and X3 are accessible at street level. In light of the limited number of delivery entrances, please respect the clearways and waiting times. All exhibitors, including those that prefer to carry out unloading themselves, must apply for loading and unloading slots.

Please contact:

IML –Messe Logistik GmbH

Austria Center Vienna, Bruno-Kreisky-Platz 1, 1220 Vienna, Austria

Contact: Mr. Robert Kokoschik or Mr. Paul Schmidt

Phone: +43 (0)1 260 69 2205, Fax: +43 (0)1 260 69 2204

Email: robert.kokoschik@iml-vienna.at

Parking

Goods vehicles: parking spaces are available at the West car park (next to Gate 1) on a first come, first served basis.

Cars: please use the Austria Center Vienna's parking garages.

Information regarding access and fees can be found online:

<https://www.acv.at/teilnehmen/anreise-und-verkehr/travelling-by-car.html>

Exhibition area technical services

General information

- Load-bearing capacity is 500kg/m² in all areas (incl. the forecourt). In exceptional cases that require the engagement of a structural engineer, the costs of this must be borne by the exhibitor.
- Water connections are only available at a selected number of locations. It is therefore recommended that for large stands, a platform as built, so that water connections remain available to other exhibitors.
- The construction of double-storey stands is permitted in Halls X3 and X4, subject to permission. Stand drawings and structural reports are required.
- Roofs may be built on single-storey stands provided that the roofing complies with the fire regulations.
- All exhibition halls have pillars – for exact positions and measurements please see the official floor plans.
- The exhibition halls have areas with limited daylight and areas with no daylight.
- The floor in exhibition halls X1, X2, X3 and X4 is covered with asphalt. It is recommended that exhibition spaces are carpeted. Tape used to fix carpet must be fully removable. If tape is used that is not fully removable or leaves traces, additional cleaning costs will be incurred.
- Oil, grease, paint and similar substances must be removed from the floor immediately. The hall floor may not be painted or drilled, nor may anything be stuck to it.
- In the exhibition halls, power supplies and other utilities are supplied to stands via the ceiling, from the hall walls or along the pillars. They are only supplied from the floor in Hall X4.

Maximum construction heights in the exhibition spaces:

Entrance Hall I/II/III:	Construction height low area: 2.80m Construction height lowest area: 2.60m
Entrance Hall IV:	Construction height high area: 5.00m
Hall E/F:	Construction height high area: 5.00m Construction height low area (below technical booths and balcony): 2.80m
Hall D:	Construction height high area: 4.00m Construction height low area (below technical booths): 2.50m
Hall G/K:	Construction height high area: 4.00m Construction height low area (below technical booths): 2.50m
Foyer A:	Construction height 2.30m
Foyer B:	Construction height 2.30m
Foyer C:	Construction height 2.30m
Foyer D/G/K:	Construction height high area 3.90m Construction height low area: 2.00m
Corridors Level 1:	Construction height 2.00m

Corridor between Foyer D and Hall X2:	Construction height 2.30m
Foyer E/F:	Construction height 2.80m
Corridors Level 2:	Construction height 2.30m
Gallery:	Construction height 2.30m
Foyer M:	Construction height 2.80m
Foyer N:	Construction height 2.80m
L 1-8:	Construction height 2.80m
Hall X1:	Construction height 3.50m (at smoke barrier: 2.50m)
Hall X2:	Construction height 3.50m
Hall X2 entrance:	Construction height 4.00m
Hall X3:	Construction height 5.50m
Hall X4:	Construction height 6.50m

General information on stand construction

Build-up of stands – General

Austria Center Vienna makes the stand area allocated to the exhibitor available without structures, technical or furnishings. The exhibitor is responsible for assembly and furnishing of the stand and for all required technical equipment. The construction and furnishing of the stand is at the exhibitor's discretion, subject always to Austria Center Vienna's regulations and instructions with regard to safety, permitted furnishings and general appearance. Exhibitors wishing to construct their own pavilions on the premises must obtain the permission of the Baupolizei (building inspectors). The proposed location, construction and design of such structures must be agreed with Austria Center Vienna before application to the Baupolizei. Austria Center Vienna accepts no liability for the safety of the design or construction of exhibition stands or the equipment contained therein.

Any requirements for alterations to the structure, furnishings and equipment of the stand and any special operating requirements imposed in the interests of public safety by the external and/or internal authorities during the official inspection must be complied with by the exhibitor promptly, before the start of the event, and at the latest before the subsequent final inspection.

Stand assembly guidelines

All entrance and exit doors to the halls, including emergency exits, escape routes, passageways, staircases, etc., must be kept completely free and unobstructed at all times. Fire safety equipment such as portable fire extinguishers, fire alarms and hydrants must be visible and accessible at all times. Fire safety equipment may not be obstructed or enclosed by structures. Stands may be constructed using the exhibitor's own materials, as described in section XIII.1.1. of the General Terms and Conditions of Contract. It is not permitted to drill, insert screws or hammer nails into the building's walls, ceilings, floors or pillars. Stands and exhibits may not impose loads on walls, pillars, windows or doors, nor may adhesives be used on these features of the building. The hanging of lightweight suspended ceilings, advertisements, banners and light fittings, etc. is not possible in all exhibition areas, and is only permitted subject to written request and approval by Austria Center Vienna. The necessary wall or ceiling mounts for hanging such items must be installed by IAKW staff or their assistants; the exhibitor shall bear the costs incurred. Pillars may be covered up to the maximum permitted construction height, provided that they are not damaged in the process. Combustible materials such as jute, crepe paper, cardboard, corrugated cardboard, reed mats or flammable plastics may not be used to construct or cover stands, or for decorative purposes. All items brought onto the premises must comply with the applicable fire safety regulations. Special protective measures must be taken in the aisles of the exhibition space, during build-up and breakdown, or otherwise special care must be taken to prevent damage to floors. Wood cutting and shaping tools must have dust collector

bags. Painting and wallpapering is only permitted in the exhibition halls if the floors are first covered using PVC sheeting.

Utilities

Special requirements for electrical, telecommunications and water connections can only be met where permitted by the official regulations and the technical services in the exhibition halls. Such services shall be provided at the exhibitor's expense. Requests must be made in writing. The installation of all such connections requires Austria Center Vienna's permission, and may only be undertaken by skilled personnel employed by Austria Center Vienna, or by approved Austria Center Vienna specialist subcontractors on behalf of and for the account of the exhibitor. No changes to such connections by the exhibitor are permitted. The exhibitor must comply with the rules and regulations of IAKW-AG and the telecommunications, electricity and water companies. Austrian safety regulations must be complied with. Infringements of regulations will result in the immediate disconnection and removal of the connection, and the exhibitor shall not be entitled to claim damages. A three-phase power supply with approx. 3 x 400/230V and alternating current with 230V and 50Hz frequency with TN earthing are available. There are residual current circuit breakers in the exhibition halls. Austria Center Vienna shall not be liable for any loss or damage resulting from technical defects. In the event of non-compliance with these regulations and instructions Austria Center Vienna may, after expiry of due notice given for remedy of the breach, make any improvements or modifications it deems necessary, at the exhibitor's expense.

Approval of construction

It is the exhibitor's responsibility to send a drawing of the proposed stand construction (floor plan and elevation) for approval, at its earliest convenience. With the exception of shell scheme stands, this regulation applies to all self-constructed stands and all stand assemblies that include rigging. Two-storey constructions are only possible in Halls X3 and X4.

Suspension points/rigging

Suspension points may be mounted in the exhibition halls and in the centre of the Entrance Hall. All suspension points must be inspected and approved by Austria Center Vienna. The weights of suspended objects must be supplied for this purpose. All Exhibition Halls are equipped with a ceiling grid, from which objects can be suspended by a rigging master employed by Austria Center Vienna. Suspension points outside this grid need to be constructed, which means they will be positioned lower than points directly on the grid. Different rates are charged for rigging suspension points outside the grid. All suspended objects need to be inspected and approved on-site by a structural engineer once mounting is completed.

Connection to electricity supply

A power package is required in order for any kind of power connection to be supplied. The type of connection required should be indicated on the order form, and all the connections required for electrical devices, lighting, etc. should be listed.

To make sure that power connections are available at the right locations, a sketch must be provided together with the order form, indicating the required connections on the service sheet for the technical layout.

For connections of over 6 kW, consumption cost is determined by the actual installed load, which is recorded by the inspecting electrician in the course of the event.

Electrical installation work can be ordered from our external partners or from a licensed electrical firm of the exhibitor's choice, which must submit a report on the electrical wiring installed („*Elektrobefund*

VD 390“) to the hall manager on the last assembly day at the latest (see House Rules & Regulations), including details of all connections installed.

Water

Water pipe installations to and from the service pipes may only be carried out by the external partner contracted by Austria Center Vienna. Water connections cannot be installed in areas with parquet flooring. In the entrance hall, the total number of water connections is limited to four, and these may only be along the wall (two connections on each side). Water connections in the gallery are also limited to four connections along the walls. Other locations must be approved by Austria Center Vienna.

The flat rate includes the costs of providing a connection, water supply costs and drainage connection charges for one tap at the stand. Connection of a sanitary fitting (e.g. sink) provided by the customer is possible upon request and by arrangement. Repairs to equipment provided by the exhibitor will be charged at cost. Please be advised that such repair work cannot be performed on the last move-in day. The equipment and necessary siphons, fittings and materials will be invoiced separately. A flat rate per connection will be invoiced (for supply and drainage) for the duration of the event.

Please note the following points:

In order to prevent blockages, food waste and coffee grounds must not be disposed of in sinks.

Please observe the following important instructions:

- All branch pipes must have a main stopcock, which must be accessible at all times and appropriately protected against unauthorised tampering by means of a special lock.
- Installation of water connections is dependent on the existence of a direct sewerage connection for the water used. Drainage of waste water into natural springs is normally prohibited and may require an official permit. In some cases mud traps and grease extractors must be properly fitted ahead of the junction of the drain with the sewer system.
- All plumbing work must comply with current regulations, and will be examined at the time of the official inspection of the event.
- To ensure that the taps are installed at the position where they are required, a sketch of the water connections ordered should be submitted together with the order for the connections.

Dismantling and removal

Removal of exhibits and breakdown of stands before the end of the event is prohibited. After removing exhibits and dismantling the stand, the exhibitor must leave the hired space in the same condition it was in when it was first placed at the exhibitor's disposal. Any damages or failure to leave the premises in a clean state will be rectified by Austria Center Vienna, and the related costs will be charged to the Contractual Partner. In the event that the stand is not vacated on time, Austria Center Vienna shall be entitled, at the Contractual Partner's expense:

- a. to have any materials, objects or packaging belonging to the exhibitor removed from the site and stored;
- b. to return the area to the condition it was in when placed at the exhibitor's disposal.

In such case Austria Center Vienna is entitled to charge the exhibitor for any storage or other costs. The exhibitor bears the risk for any materials, goods and packaging stored on the Contractual Partner's behalf.

Materials, goods and packaging material not collected by the exhibitor within three months of the end of the exhibition shall become the property of Austria Center Vienna unless the exhibitor has reached an agreement with Austria Center Vienna for the safekeeping and storage of such materials, goods or packaging. The exhibitor shall have no claim to compensation by the Austria Center Vienna on his own behalf or that of third parties if the Austria Center Vienna becomes the owner of the goods in the manner described above.

Cleaning and waste disposal

Cleaning of the aisles will be arranged by the venue once a day. Exhibitors must order cleaning services for their stands separately.

Services include cleaning of the floor, tables and chairs and all horizontal surfaces up to a height of 1.70m (not including exhibits and locked cabinets). Prices are quoted per square meter of exhibition space and include a thorough clean once before the start of the event, as well as daily cleaning (not including exhibits). Daily cleaning on event days takes place before the event opens. Complaints about cleaning services can only be considered if made on the same day as the inadequacies are noticed.

Waste separation and waste disposal

The exhibitor is required to separate waste strictly in accordance with the provisions of the *Abfallwirtschaftsgesetz* (Waste Management Act) and accompanying regulations, and is required to appoint a special waste disposal representative. Additional costs resulting from improper waste disposal will be charged to the Contractual Partner.

We would like to point out that it is not permitted to deposit waste of any kind on the exhibition premises. Any materials left behind will be disposed of, without ascertaining their value, at the exhibitor's expense.

Austrian packaging regulations that entered into force in 1993 introduced a statutory obligation to separate refuse into individual, recyclable materials. Organisers, exhibitors and stand builders are therefore required to contribute towards the avoidance of waste, and the recycling and proper disposal of waste materials at all stages of an event.

Exhibitors are requested to prepare unavoidable waste for disposal by separating it by type during the move-in and move-out periods and the event itself. Please find more information on licence agreements with ARA AG under <http://www.ara.at/e/clients/compliance-and-license-partnership.html>.

Damage and insurance

No part of the premises may be damaged or disfigured in any way. Should any damage occur, the exhibitor will be invoiced for the costs of repairs.

Exhibitors are kindly asked to acquire sufficient insurance, such as public liability insurance covering all injuries to persons and damages that might occur in connection with the exhibition. It is also recommended that exhibitors take out additional coverage against loss or damage to exhibition materials during transportation and during the exhibition itself. Austria Center Vienna shall not be liable for any loss or damage to exhibition materials.

Fire and safety regulations

Any goods on exhibitors' stands will constitute part of their stand and will be subject to these regulations.

General materials

Stand construction, installation of materials and structures supporting posters should be sufficiently stable to ensure public safety. Exhibit cases and displays should be sanded down/finished to ensure that they will not inflict cuts. Clear glass elements should display warning signs at eye level.

Stand walls

Stand walls must be made of classified fire-retardant materials, i.e. as good as or better than wood. Particle board, non-porous fibreboard and plywood are acceptable.

Decorative materials

Fire-retardant materials have to be approved in accordance with one or more of the following classifications:

SS 02 48 21, SIS 65 00 82, Euroclass A1, A2 or B-s1 d0.

Type approvals or certificates must be available at the stand, unless it is made clear in some other way that the material is approved. Cloth ceilings and other decor must be impregnated against fire. All approvals and certificates must be available in German or English, or an approved translation must be provided. Please also find below/attached the security regulations for decoration and materials.

Equipment brought onto the premises

If an exhibitor intends to exhibit, use, demonstrate or store flammable, explosive, burning or red-hot items, or items that emit radioactivity or ionising rays, or liquid gas or other pressurised gas bottles on the premises managed by the IAKW-AG (Austria Center Vienna), Austria Center Vienna must be given adequate advance notice. Exhibiting, using, demonstrating and storing such items is in all events subject to Austria Center Vienna's approval and, where necessary, dependent on official authorisation. Austria Center Vienna reserves the right to have items removed from the premises at any time at the exhibitor's expense. The exhibitor or freight forwarder must obtain information in good time as to the characteristics, load-bearing capacity and dimensions of the transportation routes, lifts, doors, etc., and ensure that the size and weight of exhibits is appropriate. If exhibits are particularly large or heavy, notice of this must be given in the application for approval, so that on-site inspection can take place for the purposes of approval pursuant to section XIII.1.2. of the General Terms and Conditions of Contract. Austria Center Vienna may require that protective matting or a weight distribution plate be placed on the transportation surfaces; the costs of such measures shall be borne by the exhibitor. Austria Center Vienna accepts no liability whatsoever for damage to persons or property caused by items of any kind (including machinery and equipment) brought onto the premises.

Motor vehicles in the exhibition area

If motor vehicles are to be brought into the exhibition space, all technical safety precautions must be complied with and evidence of compliance in the form of the necessary official and technical permissions must be submitted to Austria Center Vienna. All such events require prior authorisation by the Austria Center Vienna's fire safety representative or one of his/her deputies. For petrol or diesel driven motor vehicles older than three years, the requirements are as follows: the fuel tank is to be drained and flooded with nitrogen, and the battery is to be disconnected. For each motor vehicle, the relevant Austria Center Vienna form detailing the work done is to be completed and signed by the Contracting Partner. For petrol or diesel driven motor vehicles less than three years old, the requirements are as follows: the fuel tank may contain no more than 3 litres of fuel. The battery need not necessarily be disconnected. Flooding the fuel tank with nitrogen is only required under certain circumstances and only if the authorities or Austria Center Vienna require it.

Smoking ban

Smoking is prohibited in all public indoor areas, including private areas of exhibition space.

Flammable products

Notification of the handling and installation of flammable products should be given well before the event. This must be submitted in writing, quoting the name of the event and the stand number, to the exhibition organiser or directly to Austria Center Vienna. The storage and use of compressed gas and/or liquid gas in the exhibition halls or elsewhere on the premises is not allowed. Balloons filled with flammable gas are not permitted within halls (the only authorised gas is helium). Welding and

spraying work within the confines of the exhibition premises is prohibited. Only fireproof adhesives may be used for glue work within the exhibition premises.

Open fire

The use of open fires is prohibited, as are naked flames.

Pyrotechnics

Explosive or pyrotechnic articles may not be used on or taken onto the premises of Austria Center Vienna, either indoors or outdoors, without written permission from the organiser and Austria Center Vienna.

Hot work

Hot work such as welding, soldering, cutting, and circular-motion grinding, drying, heating or work over a naked flame is not allowed within the Austria Center Vienna without special permission from Austria Center Vienna.

Emergency exits

Escape routes and emergency exits (indoors and outdoors) should be kept free of any obstruction and kept in full view at all times. Fire safety signs, emergency alarm buttons, emergency exits and exit signs may not be covered by any products/company signs, decorations or stand roofs.

Heating/cooking

Stoves, heaters and open fires may not be used for any purpose, including cooking, frying or baking. This also applies to demonstrations. Stoves and heaters can only be used in designated catering areas, which can be rented upon request.

Goods not allowed

The following goods are not permitted on the premises of the Austria Center Vienna:

- Goods causing nuisance by their smell or otherwise, or appliances emitting objectionable noises or radiating disturbing light; any hazardous objects that have not been mentioned in the stand construction design but have been introduced by the exhibitor.
- Wireless communication devices (walkie-talkies, handheld microphones, etc.) may be used as long as they do not interfere with Austria Center Vienna's technical services or appliances. Exhibitors wishing to use these devices must include the brand name and frequencies to be used when submitting their stand design for approval.

Combustion engines

Any machine (generating sets, compressors, etc.) with an internal combustion engine, whatever the use, is forbidden inside the Austria Center Vienna, with the exception of exhibited motor vehicles, subject to the guidelines above.

Storage of flammable goods

Empty packaging, refuse, wood, paper, straw, cardboard and other flammable material must not be stored in the halls.

Responsibility

Exhibitors are wholly responsible for all displays and demonstrations they organise.

ICNC, May 7 - 9, 2017

Veranstaltungsname / Name of Event	Halle & Standnr. / Hall & Standno.	Standgröße in m ² / Booth size in sqm
Firmenname / Company's name	Straße / Street	
Postleitzahl / Postal Code	Ort / Place	
Ansprechpartner / Responsible person	E-Mail / E-Mail	
Telefon / Phone	Fax / Fax	UID - Nr. / VAT-No. only for EU countries

Bitte unbedingt ausfüllen! / Please fill out!

Deadline: 30th of March, 2017

Besprechungstisch "Chrom 1" / Table "Chrome 1"



€ 31,50

Stk. /pc.

Platte weiß / tabletop white
Fußgestell chrom / legs chrome
L x B x H = 80 x 80 x 72 cm

Tisch "Chairman" / Table "Chairman"



€ 194,00

Stk. /pc.

Platte Makassar dekor / plate makassar decor
Gestell Aluminium / frame aluminium
L x B x H = 180 x 90 x 74 cm

Besprechungstisch "Chrom 2" / Table "Chrome 2"



€ 39,00

Stk. /pc.

Platte weiß / tabletop white
Fußgestell chrom / legs chrome
L x B x H = 120 x 70 x 72 cm

Tisch "Business" / Table "Business"



€ 31,50

Stk. /pc.

Platte weiß / tabletop white
Fußgestell chrom / legs chrome
ø 70 cm, H = 72 cm

Tisch "Kaffeehaus" / Table "Coffee house"



€ 46,50

Stk. /pc.

Platte weiß-beige / tabletop white-beige
Fußgestell schwarz / legs black
ø 60 cm, H = 72 cm

Tisch "Florence" / Table "Florence"



€ 38,80

Stk. /pc.

Platte lichtgrau / tabletop lightgrey
Fußgestell chrom / legs chrome
ø 70 cm, H = 72 cm

Alle Preise verstehen sich für eine Messedauer bis zu 7 Tagen sowie exkl. MWSt. und 1 % Bestandsvertragsgebühr. Preisänderungen bleiben vorbehalten.
All prices are quoted for a period of up to seven days and are quoted exclusive VAT and 1% legal charges. Subject to alteration of prices.



WICHTIG - BESTELLFRIST: Bei Bestellungen nach der Bestellfrist muss ein Manipulationszuschlag von 25% verrechnet werden!
IMPORTANT - ORDER DEADLINE: For orders received after the deadline a manipulation surcharge of 25% will be charged!

Durch seine Unterschrift bestätigt der Auftraggeber unsere allgemeine Geschäftsbedingungen (abgedruckt am Ende dieses technischen Bestellheftes) zur Kenntnis genommen zu haben und deren Inhalt als verbindlich zu akzeptieren. Erfüllungsort und Gerichtsstand ist Wien.
By signing this document the customer acknowledges our general terms and conditions (printed on the last page of this technical order form) as noted and accepts it as binding. Place of jurisdiction is Vienna.

Retour/return to:

Expoxx Messebau GmbH | 1021 Wien | Messeplatz 1
☎ FAX +43 1 72 720 - 6109 ☎ info@expoxx.at

 **DATUM**
DATE

Ort, Datum
Place, date

 **STEMPEL**
STAMP

Firmenstempel und rechtsverbindliche Unterschrift
Stamp and obligatory signature

ICNC, May 7 - 9, 2017

Veranstaltungsname / Name of Event	Halle & Standnr. / Hall & Standno.	Standgröße in m ² / Booth size in sqm
Firmenname / Company's name	Straße / Street	
Postleitzahl / Postal Code	Ort / Place	
Ansprechpartner / Responsible person	E-Mail / E-Mail	
Telefon / Phone	Fax / Fax	UID - Nr. / VAT-No. only for EU countries

Bitte unbedingt ausfüllen! / Please fill out!

Deadline: 30th of March, 2017

Tisch "Salzburg" / Table "Salzburg"



€ 36,20

Stk. /pc.

Platte lichtgrau / tabletop lightgrey
Fußgestell chrom / legs chrome
L x B x H = 80 x 80 x 70 cm

Stehtisch "Veneto" / High table "Veneto"



€ 56,00

Stk. /pc.

Glasplatte 8 mm / tabletop glass, 8 mm
Fußgestell verchromt / legs chromium
ø 60 cm, H = 103 cm

Tisch "Lifestyle" / Table "Lifestyle"



€ 46,00

Stk. /pc.

Platte weiß hochglanz / tabletop white
Gestell niro / leg niro
L x B x H = 80 x 80 x 74 cm

Stehtisch "Business" / High table "Business"



€ 36,10

Stk. /pc.

Platte weiß / tabletop white
Fußgestell chrom / legs chrome
ø 70 cm, H = 110 cm

Stehtisch "Lifestyle" / High table "Lifestyle"



€ 56,00

Stk. /pc.

Platte weiß hochglanz / tabletop white
Gestell niro / leg niro
L x B x H = 65 x 65 x 110 cm

Stehtisch "Florence" / High table "Florence"



€ 43,50

Stk. /pc.

Platte lichtgrau / tabletop lightgrey
Fußgestell chrom / legs chrome
ø 70 cm, H = 110 cm



Alle Preise verstehen sich für eine Messedauer bis zu 7 Tagen sowie exkl. MWSt. und 1 % Bestandsvertragsgebühr. Preisänderungen bleiben vorbehalten.
All prices are quoted for a period of up to seven days and are quoted exclusive VAT and 1% legal charges. Subject to alteration of prices.

WICHTIG - BESTELLFRIST: Bei Bestellungen nach der Bestellfrist muss ein Manipulationszuschlag von 25% verrechnet werden!
IMPORTANT - ORDER DEADLINE: For orders received after the deadline a manipulation surcharge of 25% will be charged!

Durch seine Unterschrift bestätigt der Auftraggeber unsere allgemeine Geschäftsbedingungen (abgedruckt am Ende dieses technischen Bestellheftes) zur Kenntnis genommen zu haben und deren Inhalt als verbindlich zu akzeptieren. Erfüllungsort und Gerichtsstand ist Wien.
By signing this document the customer acknowledges our general terms and conditions (printed on the last page of this technical order form) as noted and accepts it as binding. Place of jurisdiction is Vienna.

Retour/return to:

Expoxx Messebau GmbH | 1021 Wien | Messeplatz 1
☎ FAX +43 1 72 720 - 6109 ☎ info@expoxx.at

 DATUM DATE	 STEMPEL STAMP
--	---

Ort, Datum
Place, date

Firmenstempel und rechtsverbindliche Unterschrift
Stamp and obligatory signature

ICNC, May 7 - 9, 2017

Veranstaltungsname / Name of Event	Halle & Standnr. / Hall & Standno.	Standgröße in m ² / Booth size in sqm
Firmenname / Company's name	Straße / Street	
Postleitzahl / Postal Code	Ort / Place	
Ansprechpartner / Responsible person	E-Mail / E-Mail	
Telefon / Phone	Fax / Fax	UID - Nr. / VAT-No. only for EU countries

Bitte unbedingt ausfüllen! / Please fill out!

Deadline: 30th of March, 2017

Couchtisch "Cosa" / Couch table "Cosa"



€ 44,80

Stk./pc.

Couchtisch "Cosa" / Couchtable "Cosa", Holz / wood
 Farbe / colour: Birke / birch schwarz / black
 L x B x H = 55 x 55 x 45 cm

Barhocker "Standard" / Barstool "Standard"



€ 28,00

Stk./pc.

Gestell chrom / frame chrome
 Polster schwarz / upholstery black
 H = 80 cm

Couchtisch "Milano" / Couch table "Milano"



€ 66,00

Stk./pc.

Glasplatte / tabletop glass
 Gestell chrom / frame chrome
 L x B x H = 65 x 65 x 38 cm

Barhocker "Zeta" / Barstool "Zeta"



€ 32,40

Stk./pc.

Gestell chrom / frame chrome
 Polster schwarz / upholstery black
 H = 80 cm

Couchtisch "Napoli" / Couch table "Napoli"



€ 54,00

Stk./pc.

aufgelegte Glasplatte / tabletop glass, L x B x H = 45 x 45 x 45 cm
 Unterteil Lederhocker "Napoli" / leathertable "Napoli"
 Farbe / colour: weiß / white beige / beige schwarz / black

Barhocker "Florence" / Barstool "Florence"



€ 40,20

Stk./pc.

Gestell chrom / frame chrome
 Polster schwarz / upholstery black
 H = 72 cm

Alle Preise verstehen sich für eine Messedauer bis zu 7 Tagen sowie exkl. MWSt. und 1 % Bestandsvertragsgebühr. Preisänderungen bleiben vorbehalten.
 All prices are quoted for a period of up to seven days and are quoted exclusive VAT and 1% legal charges. Subject to alteration of prices.

WICHTIG - BESTELLFRIST: Bei Bestellungen nach der Bestellfrist muss ein Manipulationszuschlag von 25% verrechnet werden!
IMPORTANT - ORDER DEADLINE: For orders received after the deadline a manipulation surcharge of 25% will be charged!

Durch seine Unterschrift bestätigt der Auftraggeber unsere allgemeine Geschäftsbedingungen (abgedruckt am Ende dieses technischen Bestellheftes) zur Kenntnis genommen zu haben und deren Inhalt als verbindlich zu akzeptieren. Erfüllungsort und Gerichtsstand ist Wien.
 By signing this document the customer acknowledges our general terms and conditions (printed on the last page of this technical order form) as noted and accepts it as binding. Place of jurisdiction is Vienna.

Retour/return to:

Expoxx Messebau GmbH | 1021 Wien | Messeplatz 1
 ☎ FAX +43 1 72 720 - 6109 ☎ info@expoxx.at

DATUM DATE	STEMPEL STAMP
----------------------	-------------------------

Ort, Datum
Place, date

Firmenstempel und rechtsverbindliche Unterschrift
Stamp and obligatory signature

ICNC, May 7 - 9, 2017

Veranstaltungsname / Name of Event	Halle & Standnr. / Hall & Standno.	Standgröße in m ² / Booth size in sqm
Firmenname / Company's name	Straße / Street	
Postleitzahl / Postal Code	Ort / Place	
Ansprechpartner / Responsible person	E-Mail / E-Mail	
Telefon / Phone	Fax / Fax	UID - Nr. / VAT-No. only for EU countries

Bitte unbedingt ausfüllen! / Please fill out!

Deadline: 30th of March, 2017

Barhocker "Capri" / Barstool "Capri"



€ 46,80

Stk. /pc.

Gestell chrom / frame chrome, Sitz ABS Kunststoff / seat plastics
 H = 60-81 cm, verstellbar / adjustable
 Farbe / colour: weiß / white silber / silver
 rot / red schwarz / black

Bürodrehstuhl / Office chair



€ 43,00

Stk. /pc.

Gestell schwarz / frame black
 Polster schwarz / upholstery black

Barhocker "Prato" / Barstool "Prato"



€ 54,50

Stk. /pc.

Gestell chrom / frame chrome
 Sitz Kunststoff / seat plastics, H = 60 - 74 cm
 Farbe / colour: weiß / white schwarz / black

Sessel "Tosca" / Chair "Tosca"



€ 18,00

Stk. /pc.

Gestell chrom / frame chrome
 Sitz Kunststoff dunkelgrau / plastic seat dark-grey
 Reihenverbindung / with row-connection

Barhocker "Lifestyle" / Barstool "Lifestyle"



€ 57,00

Stk. /pc.

Gestell chrom / frame chrome
 Polster schwarzes Leder / upholstery black leather
 H = 70 cm
 Farbe / colour: weiß / white schwarz / black

Sessel "Alice" / Chair "Alice"



€ 29,00

Stk. /pc.

Gestell chrom / frame chrome
 Sitzfläche Leder, schwarz / leather seat, black

Alle Preise verstehen sich für eine Messedauer bis zu 7 Tagen sowie exkl. MWSt. und 1 % Bestandsvertragsgebühr. Preisänderungen bleiben vorbehalten.
 All prices are quoted for a period of up to seven days and are quoted exclusive VAT and 1% legal charges. Subject to alteration of prices.

WICHTIG - BESTELLFRIST: Bei Bestellungen nach der Bestellfrist muss ein Manipulationszuschlag von 25% verrechnet werden!
IMPORTANT - ORDER DEADLINE: For orders received after the deadline a manipulation surcharge of 25% will be charged!

Durch seine Unterschrift bestätigt der Auftraggeber unsere allgemeine Geschäftsbedingungen (abgedruckt am Ende dieses technischen Bestellheftes) zur Kenntnis genommen zu haben und deren Inhalt als verbindlich zu akzeptieren. Erfüllungsort und Gerichtsstand ist Wien.
 By signing this document the customer acknowledges our general terms and conditions (printed on the last page of this technical order form) as noted and accepts it as binding. Place of jurisdiction is Vienna.

Retour/return to:

Expoxx Messebau GmbH | 1021 Wien | Messeplatz 1
 ☎ FAX +43 1 72 720 - 6109 ☎ info@expoxx.at

DATUM
DATE

Ort, Datum
 Place, date

STEMPEL
STAMP

Firmenstempel und rechtsverbindliche Unterschrift
 Stamp and obligatory signature

ICNC, May 7 - 9, 2017

Veranstaltungsname / Name of Event	Halle & Standnr. / Hall & Standno.	Standgröße in m ² / Booth size in sqm
Firmenname / Company's name	Straße / Street	
Postleitzahl / Postal Code	Ort / Place	
Ansprechpartner / Responsible person	E-Mail / E-Mail	
Telefon / Phone	Fax / Fax	UID - Nr. / VAT-No. only for EU countries

Bitte unbedingt ausfüllen! / Please fill out!

Deadline: 30th of March, 2017

Sessel "Disco" / Chair "Disco"



€ 28,50

Stk. /pc.

Gestell chrom / frame chrome
 Polsterung schwarz / upholstery black

Sessel "Kaffeehaus" (Geflecht) / Chair "Kaffeehaus" (Weave)



€ 29,50

Stk. /pc.

Gestell Stahlrohr schwarz / frame steel black
 Sitzgeflecht beige / seat mashwork beige

Sessel "Comodo" / Chair "Comodo"

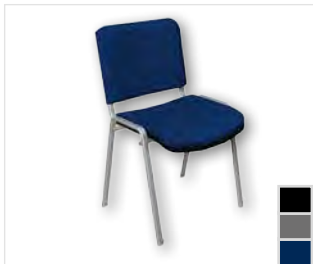

€ 28,50

Stk. /pc.

Gestell chrom / frame chrome
 Sitzfläche Polster / upholstered seat
 Farbe / colour: blau / blue grau / grey schwarz / black

Sessel "Kaffeehaus" (Holz) / Chair "Kaffeehaus" (Wood)



€ 30,90

Stk. /pc.

Gestell Holz, schwarz / frame wood, black
 Sitz schwarz / seat black

Sessel "Salzburg" / Chair "Salzburg"



€ 29,00

Stk. /pc.

Gestell anthrazit / frame anthracite
 Sitzfläche Buche / seat beech

Sessel "Lifestyle" / Chair "Lifestyle"



€ 31,00

Stk. /pc.

Gestell chrom / frame chrome,
 Sitzfläche weiß / seat white

Alle Preise verstehen sich für eine Messedauer bis zu 7 Tagen sowie exkl. MWSt. und 1 % Bestandsvertragsgebühr. Preisänderungen bleiben vorbehalten.
 All prices are quoted for a period of up to seven days and are quoted exclusive VAT and 1% legal charges. Subject to alteration of prices.

WICHTIG - BESTELFRIST: Bei Bestellungen nach der Bestellfrist muss ein Manipulationszuschlag von 25% verrechnet werden!
IMPORTANT - ORDER DEADLINE: For orders received after the deadline a manipulation surcharge of 25% will be charged!

Durch seine Unterschrift bestätigt der Auftraggeber unsere allgemeine Geschäftsbedingungen (abgedruckt am Ende dieses technischen Bestellheftes) zur Kenntnis genommen zu haben und deren Inhalt als verbindlich zu akzeptieren. Erfüllungsort und Gerichtsstand ist Wien.
 By signing this document the customer acknowledges our general terms and conditions (printed on the last page of this technical order form) as noted and accepts it as binding. Place of jurisdiction is Vienna.

Retour/return to:

Expoxx Messebau GmbH | 1021 Wien | Messeplatz 1
 ☎ FAX +43 1 72 720 - 6109 ☎ info@expoxx.at

DATUM DATE	STEMPEL STAMP
----------------------	-------------------------

Ort, Datum
 Place, date

Firmenstempel und rechtsverbindliche Unterschrift
 Stamp and obligatory signature

ICNC, May 7 - 9, 2017

Veranstaltungsname / Name of Event	Halle & Standnr. / Hall & Standno.	Standgröße in m ² / Booth size in sqm
Firmenname / Company's name	Straße / Street	
Postleitzahl / Postal Code	Ort / Place	
Ansprechpartner / Responsible person	E-Mail / E-Mail	
Telefon / Phone	Fax / Fax	UID - Nr. / VAT-No. only for EU countries

Bitte unbedingt ausfüllen! / Please fill out!

Deadline: 30th of March, 2017

Lederfauteuil "Milano" / Leatherchair "Milano"



€ 130,50
 Stk. /pc.

Polster schwarzes Leder / upholstery black leather
 B x H x T = 65 x 66 x 71 cm

Lederfauteuil "Cosa" / Leatherchair "Cosa"



€ 105,00
 Stk. /pc.

Polster Leder / upholstery leather
 B x H x T = 70 x 78 x 61 cm
 Farbe / colour: weiß / white schwarz / black rot / red

Ledercouch "Milano" / Leathercouch "Milano"



€ 218,00
 Stk. /pc.

Polster schwarzes Leder / upholstery black leather
 B x H x T = 120 x 66 x 71 cm

Ledercouch "Cosa" / Leathercouch "Cosa"



€ 187,50
 Stk. /pc.

Polster Leder / upholstery leather
 B x H x T = 126 x 78 x 61 cm
 Farbe / colour: weiß / white schwarz / black

Sitzbank "Napoli" / Bench "Napoli"



€ 73,50
 Stk. /pc.

Polster Leder / upholstery leather
 Farbe / colour: weiß / white beige / beige schwarz / black
 B x H x T = 90 x 45 x 45 cm

Hocker "Napoli" / Stool "Napoli"



€ 49,00
 Stk. /pc.

Polster Leder / upholstery leather
 Farbe / colour: weiß / white beige / beige schwarz / black
 B x H x T = 45 x 45 x 45 cm

Alle Preise verstehen sich für eine Messedauer bis zu 7 Tagen sowie exkl. MWSt. und 1 % Bestandsvertragsgebühr. Preisänderungen bleiben vorbehalten.
 All prices are quoted for a period of up to seven days and are quoted exclusive VAT and 1% legal charges. Subject to alteration of prices.

WICHTIG - BESTELLFRIST: Bei Bestellungen nach der Bestellfrist muss ein Manipulationszuschlag von 25% verrechnet werden!
IMPORTANT - ORDER DEADLINE: For orders received after the deadline a manipulation surcharge of 25% will be charged!

Durch seine Unterschrift bestätigt der Auftraggeber unsere allgemeine Geschäftsbedingungen (abgedruckt am Ende dieses technischen Bestellheftes) zur Kenntnis genommen zu haben und deren Inhalt als verbindlich zu akzeptieren. Erfüllungsort und Gerichtsstand ist Wien.
 By signing this document the customer acknowledges our general terms and conditions (printed on the last page of this technical order form) as noted and accepts it as binding. Place of jurisdiction is Vienna.

Retour/return to:

Expoxx Messebau GmbH | 1021 Wien | Messeplatz 1
 ☎ FAX +43 1 72 720 - 6109 ☎ info@expoxx.at

DATUM
 DATE

Ort, Datum
 Place, date

STEMPEL
 STAMP

Firmenstempel und rechtsverbindliche Unterschrift
 Stamp and obligatory signature

ICNC, May 7 - 9, 2017

Veranstaltungsname / Name of Event	Halle & Standnr. / Hall & Standno.	Standgröße in m ² / Booth size in sqm
Firmenname / Company's name	Straße / Street	
Postleitzahl / Postal Code	Ort / Place	
Ansprechpartner / Responsible person	E-Mail / E-Mail	
Telefon / Phone	Fax / Fax	UID - Nr. / VAT-No. only for EU countries

Bitte unbedingt ausfüllen! / Please fill out!

Deadline: 30th of March, 2017

Set "Tosca" / Set "Tosca"



€ 73,00

Stk. /pc.

3 Stk. Sessel "Tosca" / 3 pcs chair "Tosca"
1 Stk. Tisch "Chrom1" / 1 pc table "Chrome1"

Set "Alice" / Set "Alice"



€ 110,50

Stk. /pc.

3 Stk. Sessel "Alice" / 3 pcs chair "Alice"
1 Stk. Tisch "Florence" / 1 pc table "Florence"

Set "Standard" / Set "Standard"

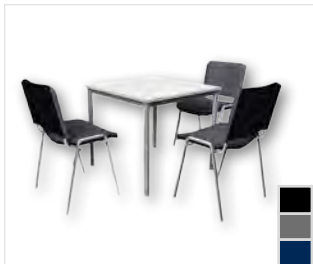

€ 103,50

Stk. /pc.

3 Stk. Sessel "Comodo" / 3 pcs chair "Comodo"
1 Stk. Tisch "Chrom1" / 1 pc table "Chrome1"
Farbe / colour: grau / grey blau / blue schwarz / black

Set "Zeta" / Set "Zeta"



€ 116,00

Stk. /pc.

3 Stk. Barhocker "Zeta" / 3 pcs barstool "Zeta"
1 Stk. Stehtisch "Business" / 1 pc high table "Business"

Set "Salzburg" / Set "Salzburg"



€ 111,00

Stk. /pc.

3 Stk. Sessel "Salzburg" / 3 pcs chair "Salzburg"
1 Stk. Tisch "Salzburg" / 1 pc table "Salzburg"

Set "Florence" / Set "Florence"



€ 145,00

Stk. /pc.

3 Stk. Barhocker "Florence" / 3 pcs barstool "Florence"
1 Stk. Stehtisch "Florence" / 1 pc high table "Florence"

Alle Preise verstehen sich für eine Messedauer bis zu 7 Tagen sowie exkl. MWSt. und 1 % Bestandsvertragsgebühr. Preisänderungen bleiben vorbehalten.
All prices are quoted for a period of up to seven days and are quoted exclusive VAT and 1% legal charges. Subject to alteration of prices.

WICHTIG - BESTELLFRIST: Bei Bestellungen nach der Bestellfrist muss ein Manipulationszuschlag von 25% verrechnet werden!
IMPORTANT - ORDER DEADLINE: For orders received after the deadline a manipulation surcharge of 25% will be charged!

Durch seine Unterschrift bestätigt der Auftraggeber unsere allgemeine Geschäftsbedingungen (abgedruckt am Ende dieses technischen Bestellheftes) zur Kenntnis genommen zu haben und deren Inhalt als verbindlich zu akzeptieren. Erfüllungsort und Gerichtsstand ist Wien.
By signing this document the customer acknowledges our general terms and conditions (printed on the last page of this technical order form) as noted and accepts it as binding. Place of jurisdiction is Vienna.

Retour/return to:

Expoxx Messebau GmbH | 1021 Wien | Messeplatz 1
☎ FAX +43 1 72 720 - 6109 ☎ info@expoxx.at

 **DATUM**
DATE

Ort, Datum
Place, date

 **STEMPEL**
STAMP

Firmenstempel und rechtsverbindliche Unterschrift
Stamp and obligatory signature

ICNC, May 7 - 9, 2017

Veranstaltungsname / Name of Event	Halle & Standnr. / Hall & Standno.	Standgröße in m ² / Booth size in sqm
Firmenname / Company's name	Straße / Street	
Postleitzahl / Postal Code	Ort / Place	
Ansprechpartner / Responsible person	E-Mail / E-Mail	
Telefon / Phone	Fax / Fax	UID - Nr. / VAT-No. only for EU countries

Bitte unbedingt ausfüllen! / Please fill out!

Deadline: 30th of March, 2017

Set "Kaffeehaus" / Set "Kaffeehaus"



€ 122,50

Stk. /pc.

3 Stk. Sessel "Kaffeehaus" / 3 pcs chair "Coffee house"
1 Stk. Tisch "Kaffeehaus" / 1 pc table "Coffee house"
Farbe / colour: beige / beige schwarz / black

Set "Napoli 2" / Set "Napoli 2"



€ 314,00

Stk. /pc.

2 Stk. Sitzbänke, 2 Stk. Hocker / 2 pcs benches, 2 pcs stools
2 Stk. Couchtisch, 2 pcs couch tables
Farbe / colour: weiß / white beige / beige schwarz / black

Set "Lifestyle 1" / Set "Lifestyle 1"



€ 122,50

Stk. /pc.

3 Stk. Sessel "Lifestyle" / 3 pcs chair "Lifestyle"
1 Stk. Tisch "Lifestyle" / 1 pc table "Lifestyle"

Set "Cosa" / Set "Cosa"



€ 326,00

Stk. /pc.

3 Stk. Fauteuil "Cosa" / 3 pcs leatherchair "Cosa"
1 Stk. Couchtisch "Cosa" / 1 pc couch table "Cosa"
Farbe / colour: weiß / white schwarz / black rot / red

Set "Lifestyle 2" / Set "Set Lifestyle 2"



€ 175,50

Stk. /pc.

1 Stk. Stehtisch "Lifestyle" / 1 pc high table "Lifestyle"
3 Stk. Barhocker "Capri" / 3 pcs barstool "Capri"
Farbe / colour: weiß / white silber / silver
 rot / red schwarz / black

Set "Napoli 1" / Set "Napoli 1"



€ 404,00

Stk. /pc.

2 Stk. Sitzbänke / 2 pcs benches, 2 Stk. Hocker 30° / 2 pcs stools 30°
2 Stk. Hocker 60° / 2 pcs stools 60°, 2 Stk. Couchtisch / 2 pcs couchtables
Farbe / colour: weiß / white beige / beige schwarz / black

Alle Preise verstehen sich für eine Messedauer bis zu 7 Tagen sowie exkl. MWSt. und 1 % Bestandsvertragsgebühr. Preisänderungen bleiben vorbehalten.
All prices are quoted for a period of up to seven days and are quoted exclusive VAT and 1% legal charges. Subject to alteration of prices.

WICHTIG - BESTELLFRIST: Bei Bestellungen nach der Bestellfrist muss ein Manipulationszuschlag von 25% verrechnet werden!
IMPORTANT - ORDER DEADLINE: For orders received after the deadline a manipulation surcharge of 25% will be charged!

Durch seine Unterschrift bestätigt der Auftraggeber unsere allgemeine Geschäftsbedingungen (abgedruckt am Ende dieses technischen Bestellheftes) zur Kenntnis genommen zu haben und deren Inhalt als verbindlich zu akzeptieren. Erfüllungsort und Gerichtsstand ist Wien.
By signing this document the customer acknowledges our general terms and conditions (printed on the last page of this technical order form) as noted and accepts it as binding. Place of jurisdiction is Vienna.

Retour/return to:

Expoxx Messebau GmbH | 1021 Wien | Messeplatz 1
☎ FAX +43 1 72 720 - 6109 ☎ info@expoxx.at

 **DATUM**
DATE

Ort, Datum
Place, date

 **STEMPEL**
STAMP

Firmenstempel und rechtsverbindliche Unterschrift
Stamp and obligatory signature

ICNC, May 7 - 9, 2017

Veranstaltungsname / Name of Event	Halle & Standnr. / Hall & Standno.	Standgröße in m ² / Booth size in sqm
Firmenname / Company's name	Straße / Street	
Postleitzahl / Postal Code	Ort / Place	
Ansprechpartner / Responsible person	E-Mail / E-Mail	
Telefon / Phone	Fax / Fax	UID - Nr. / VAT-No. only for EU countries

Bitte unbedingt ausfüllen! / Please fill out!

Deadline: 30th of March, 2017

Wandkleiderhaken / Wall coat hook



€ 21,40

Stk. /pc.

dreiteilig / three-piece
 silber / silver

Rollspiegel / Rolling mirror



€ 158,70

Stk. /pc.

H = 183 cm, B = 50 cm

Kleiderstange / Clothes rack



€ 29,70

Stk. /pc.

(ohne Kleiderbügel / without clamp)
 höhenverstellbar / height adjustable
 L = 100 cm 150 cm 200 cm

Hängespiegel 150 / Hanging mirror 150



€ 50,00

Stk. /pc.

B x H = 50 x 150 cm

Konfektionskleiderständer / Tailor's clothes rack



€ 57,80

Stk. /pc.

L x H = 145 x 155 cm

Garderobenständer / Coat rack



€ 34,60

Stk. /pc.

H = 183 cm, Ø 50 cm
 Farbe / colour: weiß / white schwarz / black

Alle Preise verstehen sich für eine Messedauer bis zu 7 Tagen sowie exkl. MWSt. und 1 % Bestandsvertragsgebühr. Preisänderungen bleiben vorbehalten.
 All prices are quoted for a period of up to seven days and are quoted exclusive VAT and 1% legal charges. Subject to alteration of prices.

WICHTIG - BESTELLFRIST: Bei Bestellungen nach der Bestellfrist muss ein Manipulationszuschlag von 25% verrechnet werden!
IMPORTANT - ORDER DEADLINE: For orders received after the deadline a manipulation surcharge of 25% will be charged!

Durch seine Unterschrift bestätigt der Auftraggeber unsere allgemeine Geschäftsbedingungen (abgedruckt am Ende dieses technischen Bestellheftes) zur Kenntnis genommen zu haben und deren Inhalt als verbindlich zu akzeptieren. Erfüllungsort und Gerichtsstand ist Wien.
 By signing this document the customer acknowledges our general terms and conditions (printed on the last page of this technical order form) as noted and accepts it as binding. Place of jurisdiction is Vienna.

Retour/return to:

Expoxx Messebau GmbH | 1021 Wien | Messeplatz 1
 ☎ FAX +43 1 72 720 - 6109 ☎ info@expoxx.at

DATUM DATE	STEMPEL STAMP
----------------------	-------------------------

Ort, Datum
Place, date

Firmenstempel und rechtsverbindliche Unterschrift
Stamp and obligatory signature

ICNC, May 7 - 9, 2017

Veranstaltungsname / Name of Event	Halle & Standnr. / Hall & Standno.	Standgröße in m ² / Booth size in sqm
Firmenname / Company's name	Straße / Street	
Postleitzahl / Postal Code	Ort / Place	
Ansprechpartner / Responsible person	E-Mail / E-Mail	
Telefon / Phone	Fax / Fax	UID - Nr. / VAT-No. only for EU countries

Deadline: 30th of March, 2017

Bitte unbedingt ausfüllen! / Please fill out!

Prospektständer A4 / Leaflet dispenser A4



€ 61,60

Stk. /pc.

3 Stk Fächer A4 / 3 pc. shelves A4
 H x B x T = 130 x 35 x 30 cm

Wandregal / Shelf unit



€ 73,80

Stk. /pc.

4 Stk. Einlegeplatten / 4 pc panels
 H x B x T = 198 x 100 x 50 cm

Prospektständer / Leaflet dispenser



€ 77,50

Stk. /pc.

3 Stk Fächer A4 / 3 pc. shelves A4
 H x B x T = 135 x 32 x 52 cm
 Farbe / colour: beton / concrete weiß / white

Absperrband / Barrier



€ 61,50

ausziehbar bis / extendible up to 150 cm
 H = 100 cm
 Farbe / colour: rot / red schwarz / black

Kaffeevollautomat / Coffee machine



€ 253,00

Stk. /pc.

ohne Bohnen / without beans
 1,3 kW / 230 V / H x B x T = 39 x 38 x 32 cm

Papierkorb / Waste paper basket



€ 7,70

Stk. /pc.

ø 28 cm, H = 34 cm

Alle Preise verstehen sich für eine Messedauer bis zu 7 Tagen sowie exkl. MWSt. und 1 % Bestandsvertragsgebühr. Preisänderungen bleiben vorbehalten.
 All prices are quoted for a period of up to seven days and are quoted exclusive VAT and 1% legal charges. Subject to alteration of prices.

WICHTIG - BESTELLFRIST: Bei Bestellungen nach der Bestellfrist muss ein Manipulationszuschlag von 25% verrechnet werden!
IMPORTANT - ORDER DEADLINE: For orders received after the deadline a manipulation surcharge of 25% will be charged!

Durch seine Unterschrift bestätigt der Auftraggeber unsere allgemeine Geschäftsbedingungen (abgedruckt am Ende dieses technischen Bestellheftes) zur Kenntnis genommen zu haben und deren Inhalt als verbindlich zu akzeptieren. Erfüllungsort und Gerichtsstand ist Wien.
 By signing this document the customer acknowledges our general terms and conditions (printed on the last page of this technical order form) as noted and accepts it as binding. Place of jurisdiction is Vienna.

Retour/return to:

Expoxx Messebau GmbH | 1021 Wien | Messeplatz 1
 ☎ FAX +43 1 72 720 - 6109 ☎ info@expoxx.at

DATUM
 DATE

Ort, Datum
 Place, date

STEMPEL
 STAMP

Firmenstempel und rechtsverbindliche Unterschrift
 Stamp and obligatory signature

ICNC, May 7 - 9, 2017

Veranstaltungsname / Name of Event	Halle & Standnr. / Hall & Standno.	Standgröße in m ² / Booth size in sqm
Firmenname / Company's name	Straße / Street	
Postleitzahl / Postal Code	Ort / Place	
Ansprechpartner / Responsible person	E-Mail / E-Mail	
Telefon / Phone	Fax / Fax	UID - Nr. / VAT-No. only for EU countries

Bitte unbedingt ausfüllen! / Please fill out!

Deadline: 30th of March, 2017

Kühlschrank / Refrigerator



€ 83,50

Stk. /pc.

140 L, 0,1 kW / 230 V
H x B x T = 85 x 50 x 55 cm

Messeküche / Fair kitchen



€ 296,00

Stk. /pc.

ohne Anschluss / without connection
Kühlschrank, Abwasch und Kochplatte / Refrigerator, sink and plate
H x B x T = 90 x 90 x 60 cm - 4,5 kW / 230 V

Spüle / Sink unit



€ 190,50

Stk. /pc.

ohne Anschluss / without connection
inkl. Unterschrank und Kleinspeicher / incl. cupboard unit
and water heater, H x B x T = 90 x 80 x 53 cm - 2,2 kW / 230 V

Spüler/ Dishwasher



€ 576,00

Stk. /pc.

- Gläserspüler / Dishwasher for glass
H x B x T = 70 x 45 x 55 cm - 2,2 kW / 230 V
- Geschirrspüler / Dishwasher professional
H x B x T = 93 x 60 x 60 cm - 5,4 kW / 400 V

Beistellschrank weiss / Sideboard white



€ 87,50

Stk. /pc.

1 Fach, Auflegeplatte, versperrbar / 1 shelf, support plate, lockable
H x B x T = 85 x 97 x 44 cm

Beistellschrank "Standard" weiss / Sideboard "standard" white



€ 79,00

Stk. /pc.

1 Fach, versperrbar / 1 shelf, lockable
H x B x T = 85 x 97 x 44 cm

Alle Preise verstehen sich für eine Messedauer bis zu 7 Tagen sowie exkl. MWSt. und 1 % Bestandsvertragsgebühr. Preisänderungen bleiben vorbehalten.
All prices are quoted for a period of up to seven days and are quoted exclusive VAT and 1% legal charges. Subject to alteration of prices.

WICHTIG - BESTELLFRIST: Bei Bestellungen nach der Bestellfrist muss ein Manipulationszuschlag von 25% verrechnet werden!
IMPORTANT - ORDER DEADLINE: For orders received after the deadline a manipulation surcharge of 25% will be charged!

Durch seine Unterschrift bestätigt der Auftraggeber unsere allgemeine Geschäftsbedingungen (abgedruckt am Ende dieses technischen Bestellheftes) zur Kenntnis genommen zu haben und deren Inhalt als verbindlich zu akzeptieren. Erfüllungsort und Gerichtsstand ist Wien.
By signing this document the customer acknowledges our general terms and conditions (printed on the last page of this technical order form) as noted and accepts it as binding. Place of jurisdiction is Vienna.

Retour/return to:

Expoxx Messebau GmbH | 1021 Wien | Messeplatz 1
☎ FAX +43 1 72 720 - 6109 ☎ info@expoxx.at

 DATUM
DATE

Ort, Datum
Place, date

 STEMPEL
STAMP

Firmenstempel und rechtsverbindliche Unterschrift
Stamp and obligatory signature

ICNC, May 7 - 9, 2017

Veranstaltungsname / Name of Event	Halle & Standnr. / Hall & Standno.	Standgröße in m ² / Booth size in sqm
Firmenname / Company's name	Straße / Street	
Postleitzahl / Postal Code	Ort / Place	
Ansprechpartner / Responsible person	E-Mail / E-Mail	
Telefon / Phone	Fax / Fax	UID - Nr. / VAT-No. only for EU countries

Bitte unbedingt ausfüllen! / Please fill out!

Deadline: 30th of March, 2017

Vitrine "Standard 1" / Showcase "Standard 1"



€ 211,00

Stk. /pc.

Schiebeglas versperbar / sliding glass lockable
H x B x T = 248 x 99 x 49,5 cm

Barpult / Bar desk



€ 99,50

Stk. /pc.

weiß / white
H x B x T = 98 x 99 x 49,5 cm, inkl. Fach / incl. shelf

Vitrine "Standard 2" / Showcase "Standard 2"



€ 243,00

Stk. /pc.

Schiebeglas versperbar / sliding glass lockable
Korpus mit Schiebetür / corpus with sliding door
H x B x T = 248 x 99 x 49,5 cm

Infopult / Information desk



€ 117,50

Stk. /pc.

versperbar, weiß / lockable, white
inkl. Fach / incl. shelf
H x B x T = 98 x 99 x 49,5 cm

Tischvitrine versperbar / Table display case lockable



€ 157,50

Stk. /pc.

Glasteil 20 cm hoch / Glass unit 20 cm high
H x B x T = 100 x 100 x 50 cm, weiß / white

Barpult m. Board, weiß / Bar desk with board, white



€ 141,00

Stk. /pc.

H x B x T = 90 | 110 x 100 x 70 cm
inkl. Fach / incl. shelf

Alle Preise verstehen sich für eine Messedauer bis zu 7 Tagen sowie exkl. MWSt. und 1 % Bestandsvertragsgebühr. Preisänderungen bleiben vorbehalten.
All prices are quoted for a period of up to seven days and are quoted exclusive VAT and 1% legal charges. Subject to alteration of prices.

WICHTIG - BESTELLFRIST: Bei Bestellungen nach der Bestellfrist muss ein Manipulationszuschlag von 25% verrechnet werden!
IMPORTANT - ORDER DEADLINE: For orders received after the deadline a manipulation surcharge of 25% will be charged!

Durch seine Unterschrift bestätigt der Auftraggeber unsere allgemeine Geschäftsbedingungen (abgedruckt am Ende dieses technischen Bestellheftes) zur Kenntnis genommen zu haben und deren Inhalt als verbindlich zu akzeptieren. Erfüllungsort und Gerichtsstand ist Wien.
By signing this document the customer acknowledges our general terms and conditions (printed on the last page of this technical order form) as noted and accepts it as binding. Place of jurisdiction is Vienna.

Retour/return to:

Expoxx Messebau GmbH | 1021 Wien | Messeplatz 1
☎ FAX +43 1 72 720 - 6109 ☎ info@expoxx.at

 **DATUM**
DATE

Ort, Datum
Place, date

 **STEMPEL**
STAMP

Firmenstempel und rechtsverbindliche Unterschrift
Stamp and obligatory signature

ICNC, May 7 - 9, 2017

Veranstaltungsname / Name of Event	Halle & Standnr. / Hall & Standno.	Standgröße in m ² / Booth size in sqm
Firmenname / Company's name	Straße / Street	
Postleitzahl / Postal Code	Ort / Place	
Ansprechpartner / Responsible person	E-Mail / E-Mail	
Telefon / Phone	Fax / Fax	UID - Nr. / VAT-No. only for EU countries

Bitte unbedingt ausfüllen! / Please fill out!

Deadline: 30th of March, 2017

Niro-Bar "D-3200" / Niro-Bar "D-3200"



€ 165,00

Stk. /pc.

Auflegeplatte carbongrau / top plate carbon-grey
 H x B x T = 105 x 100 x 50 cm
 inkl. Fach / incl. shelf

Segmentbar "D-2500" / Round bar "D-2500"



€ 361,00

Stk. /pc.

H = 90 | 120 cm, B = 190 cm
 inkl. Fach / incl. shelf

PC-Pult "Pisa" / PC-desk "Pisa"



€ 139,50

Stk. /pc.

H x B x T = 60 | 95 | 115 / 70 / 60 cm

Bar "Maxima" / Bar "Maxima"



€ 152,00

Stk. /pc.

H x B x T = 90 | 110 x 60 x 100 cm
 inkl. Fach / incl. shelf

Bar "Future" / Bar "Future"



€ 169,00

Stk. /pc.

H x B x T = 90 | 110 x 75 x 100 cm
 inkl. Fach / incl. shelf

Alle Preise verstehen sich für eine Messedauer bis zu 7 Tagen sowie exkl. MWSt. und 1 % Bestandvertragsgebühr. Preisänderungen bleiben vorbehalten.
 All prices are quoted for a period of up to seven days and are quoted exclusive VAT and 1% legal charges. Subject to alteration of prices.



WICHTIG - BESTELLFRIST: Bei Bestellungen nach der Bestellfrist muss ein Manipulationszuschlag von 25% verrechnet werden!
IMPORTANT - ORDER DEADLINE: For orders received after the deadline a manipulation surcharge of 25% will be charged!

Durch seine Unterschrift bestätigt der Auftraggeber unsere allgemeine Geschäftsbedingungen (abgedruckt am Ende dieses technischen Bestellheftes) zur Kenntnis genommen zu haben und deren Inhalt als verbindlich zu akzeptieren. Erfüllungsort und Gerichtsstand ist Wien.
 By signing this document the customer acknowledges our general terms and conditions (printed on the last page of this technical order form) as noted and accepts it as binding. Place of jurisdiction is Vienna.

Retour/return to:

Expoxx Messebau GmbH | 1021 Wien | Messeplatz 1
 ☎ FAX +43 1 72 720 - 6109 ☎ info@expoxx.at

DATUM
DATE

Ort, Datum
 Place, date

STEMPEL
STAMP

Firmenstempel und rechtsverbindliche Unterschrift
 Stamp and obligatory signature

ICNC, May 7 - 9, 2017

Veranstaltungsname / Name of Event	Halle & Standnr. / Hall & Standno.	Standgröße in m ² / Booth size in sqm
Firmenname / Company's name	Straße / Street	
Postleitzahl / Postal Code	Ort / Place	
Ansprechpartner / Responsible person	E-Mail / E-Mail	
Telefon / Phone	Fax / Fax	UID - Nr. / VAT-No. only for EU countries

Bitte unbedingt ausfüllen! / Please fill out!

Deadline: 30th of March, 2017

Wand weiß / Wall white

einseitig nutzbar / usable single sided

Wichtig / Important:
 Aus Gründen der Statik und Sicherheit werden notwendige Wandabstützungen nach Bedarf angebaut und verrechnet!
 Referring to the static and security of the booth, necessary wall support is built and invoiced as required!

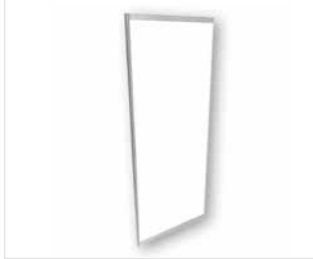

€ 38,70

Stk. /pc.

3 mm Homogenplatte / 3 mm panels,
 inkl. Steher und Zargen, incl. poles and frames
 H x B = 248 x 99 cm

Flügeltür "Stuttgart" / Wing door "Stuttgart"

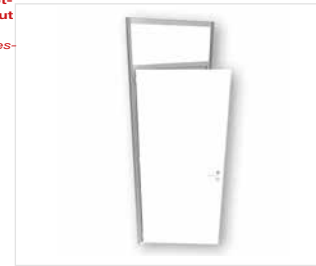

€ 157,50

Stk. /pc.

versperrbar / lockable
 H x B = 248 x 99 cm

Wand färbig / Wall coloured

einseitig nutzbar / usable single sided

Farbauswahl / choose colour:

- | | | |
|--------------------------|--------------------------|--------------------------|
| <input type="checkbox"/> | <input type="checkbox"/> | <input type="checkbox"/> |
| <input type="checkbox"/> | <input type="checkbox"/> | <input type="checkbox"/> |
| <input type="checkbox"/> | <input type="checkbox"/> | <input type="checkbox"/> |
| | <input type="checkbox"/> | <input type="checkbox"/> |



€ 53,90

Stk. /pc.

3 mm Homogenplatte / 3 mm panels,
 inkl. Steher und Zargen, incl. poles and frames,
 H x B = 248 x 99 cm

Falttüre "Business", weiß / Folding door "Business", white



€ 143,50

Stk. /pc.

versperrbar / lockable
 H x B = 248 x 99 cm

Lochwand weiß / Perforated wall white

einseitig nutzbar / usable single sided



€ 76,50

Stk. /pc.

Hartfaserplatte 3 mm, HDK weiß beschichtet / hardboard 3 mm
 HDK white covered, inkl. Steher und Zargen, incl. poles and frames
 H x B = 248 x 99 cm

Vorhang lichtgrau / Curtain lightgrey

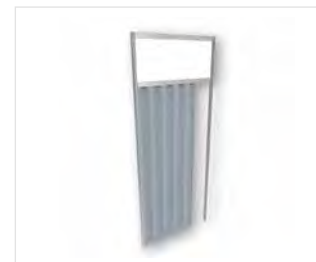

€ 67,20

Stk. /pc.

inklusive Blende / including trim
 H x B = 248 x 99 cm

Alle Preise verstehen sich für eine Messedauer bis zu 7 Tagen sowie exkl. MWSt. und 1 % Bestandsvertragsgebühr. Preisänderungen bleiben vorbehalten.
 All prices are quoted for a period of up to seven days and are quoted exclusive VAT and 1% legal charges. Subject to alteration of prices.

WICHTIG - BESTELLFRIST: Bei Bestellungen nach der Bestellfrist muss ein Manipulationszuschlag von 25% verrechnet werden!
IMPORTANT - ORDER DEADLINE: For orders received after the deadline a manipulation surcharge of 25% will be charged!

Durch seine Unterschrift bestätigt der Auftraggeber unsere allgemeine Geschäftsbedingungen (abgedruckt am Ende dieses technischen Bestellheftes) zur Kenntnis genommen zu haben und deren Inhalt als verbindlich zu akzeptieren. Erfüllungsort und Gerichtsstand ist Wien.
 By signing this document the customer acknowledges our general terms and conditions (printed on the last page of this technical order form) as noted and accepts it as binding. Place of jurisdiction is Vienna.

Retour/return to:

Expoxx Messebau GmbH | 1021 Wien | Messeplatz 1
 ☎ FAX +43 1 72 720 - 6109 ☎ info@expoxx.at

DATUM
DATE

Ort, Datum
 Place, date

STEMPEL
STAMP

Firmenstempel und rechtsverbindliche Unterschrift
 Stamp and obligatory signature

ICNC, May 7 - 9, 2017

Veranstaltungsname / Name of Event	Halle & Standnr. / Hall & Standno.	Standgröße in m ² / Booth size in sqm
Firmenname / Company's name	Straße / Street	
Postleitzahl / Postal Code	Ort / Place	
Ansprechpartner / Responsible person	E-Mail / E-Mail	
Telefon / Phone	Fax / Fax	UID - Nr. / VAT-No. only for EU countries

Bitte unbedingt ausfüllen! / Please fill out!

Deadline: 30th of March, 2017

Einschublende weiß / Infill fascia white



€ 27,40

 Stk. /pc.

3 mm Platte / 3 mm panels
Schriftfeldhöhe 28 cm / fascia 28 cm high
H x B = 38 x 99 cm

Fach (Höhe variabel) / Shelf (variable height)



max. Belastung 5kg / Fach
max. weight 5kg / shelf

€ 22,90

 Stk. /pc.

L x T = 99 x 30 cm, weiß / white
 waagrecht / horizontal
 10° 25° 45° 60° schräg / angular

Einschublende färbig / Infill fascia coloured



Farbauswahl / choose colour:

<input type="checkbox"/> 	<input type="checkbox"/> 	<input type="checkbox"/> 
<input type="checkbox"/> 	<input type="checkbox"/> 	<input type="checkbox"/> 
<input type="checkbox"/> 	<input type="checkbox"/> 	<input type="checkbox"/> 
<input type="checkbox"/> 	<input type="checkbox"/> 	<input type="checkbox"/> 

€ 30,40

 Stk. /pc.

3 mm Platte / 3 mm panels
Blendenhöhe 28 cm / fascia 28 cm high
H x B = 38 x 99 cm

Podest / Platform



€ 75,80

 Stk. /pc.

99 x 99 x 48 cm 99 x 49,5 x 48 cm
andere Abmaße / other dimensions
 ___ x ___ x ___ cm

Fachwerkblende / Frame-work fascia



€ 33,60

 Stk. /pc.

grau / grey
H x B = 38 x 99 cm

Vitrinenglasfach / Shelf for show



max. Belastung 15kg / Fach
max. weight 15kg / shelf

€ 29,00

 Stk. /pc.

L x B = 97 x 47,5 cm

Alle Preise verstehen sich für eine Messedauer bis zu 7 Tagen sowie exkl. MWSt. und 1 % Bestandsvertragsgebühr. Preisänderungen bleiben vorbehalten.
All prices are quoted for a period of up to seven days and are quoted exclusive VAT and 1% legal charges. Subject to alteration of prices.

WICHTIG - BESTELLFRIST: Bei Bestellungen nach der Bestellfrist muss ein Manipulationszuschlag von 25% verrechnet werden!
IMPORTANT - ORDER DEADLINE: For orders received after the deadline a manipulation surcharge of 25% will be charged!

Durch seine Unterschrift bestätigt der Auftraggeber unsere allgemeine Geschäftsbedingungen (abgedruckt am Ende dieses technischen Bestellheftes) zur Kenntnis genommen zu haben und deren Inhalt als verbindlich zu akzeptieren. Erfüllungsort und Gerichtsstand ist Wien.
By signing this document the customer acknowledges our general terms and conditions (printed on the last page of this technical order form) as noted and accepts it as binding. Place of jurisdiction is Vienna.

Retour/return to:

Expoxx Messebau GmbH | 1021 Wien | Messeplatz 1
☎ FAX +43 1 72 720 - 6109 ☎ info@expoxx.at

 **DATUM**
DATE

Ort, Datum
Place, date

 **STEMPEL**
STAMP

Firmenstempel und rechtsverbindliche Unterschrift
Stamp and obligatory signature

ICNC, May 7 - 9, 2017

Veranstaltungsname / Name of Event	Halle & Standnr. / Hall & Standno.	Standgröße in m ² / Booth size in sqm
Firmenname / Company's name	Straße / Street	
Postleitzahl / Postal Code	Ort / Place	
Ansprechpartner / Responsible person	E-Mail / E-Mail	
Telefon / Phone	Fax / Fax	UID - Nr. / VAT-No. only for EU countries

Bitte unbedingt ausfüllen! / Please fill out!

Deadline: 30th of March, 2017

Steher / Pole



€ 11,70

Stk. /pc.

Aluminium / aluminium
H = 248 cm

Kombidecke mit / Ceiling grid with:



€ 37,90

Stk. /pc.

Einlegeplatte / Slide in panel
H x B x T = 17,5 x 99 x 99 cm

Zarge / Frame



€ 11,70

Stk. /pc.

Aluminium / aluminium
H x B x T = 17,5 x 95 x 1,6 cm

Kombidecke mit / Ceiling grid with:



€ 38,20

Stk. /pc.

Lochblech / perforated metal sheet
H x B x T = 17,5 x 99 x 99 cm

Rasterdecke / Ceiling grid



€ 22,00

Stk. /pc.

Felder offen / fields open
H x B x T = 17,5 x 99 x 99 cm

Alle Preise verstehen sich für eine Messedauer bis zu 7 Tagen sowie exkl. MWSt. und 1 % Bestandvertragsgebühr. Preisänderungen bleiben vorbehalten.
All prices are quoted for a period of up to seven days and are quoted exclusive VAT and 1% legal charges. Subject to alteration of prices.

WICHTIG - BESTELLFRIST: Bei Bestellungen nach der Bestellfrist muss ein Manipulationszuschlag von 25% verrechnet werden!
IMPORTANT - ORDER DEADLINE: For orders received after the deadline a manipulation surcharge of 25% will be charged!

Durch seine Unterschrift bestätigt der Auftraggeber unsere allgemeine Geschäftsbedingungen (abgedruckt am Ende dieses technischen Bestellheftes) zur Kenntnis genommen zu haben und deren Inhalt als verbindlich zu akzeptieren. Erfüllungsort und Gerichtsstand ist Wien.
By signing this document the customer acknowledges our general terms and conditions (printed on the last page of this technical order form) as noted and accepts it as binding. Place of jurisdiction is Vienna.

Retour/return to:

Expoxx Messebau GmbH | 1021 Wien | Messeplatz 1
☎ FAX +43 1 72 720 - 6109 ☎ info@expoxx.at

 **DATUM**
DATE

Ort, Datum
Place, date

 **STEMPEL**
STAMP

Firmenstempel und rechtsverbindliche Unterschrift
Stamp and obligatory signature

ICNC, May 7 - 9, 2017





Veranstaltungsname / Name of Event	Halle & Standnr. / Hall & Standno.	Standgröße in m ² / Booth size in sqm
Firmenname / Company's name	Straße / Street	
Postleitzahl / Postal Code	Ort / Place	
Ansprechpartner / Responsible person	E-Mail / E-Mail	
Telefon / Phone	Fax / Fax	UID - Nr. / VAT-No. only for EU countries

Bitte unbedingt ausfüllen! / Please fill out!

Deadline: 30th of March, 2017

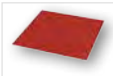
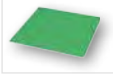

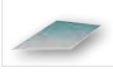

Teppichfliesen / Carpet tiles

leihweise, inkl. Verlegung / loan for use, incl. laying, L x B = 50 x 50 cm

	<input type="checkbox"/> rot / red	<input type="text"/>	€ 12,90 m ² / sqm
	<input type="checkbox"/> grün / green	<input type="text"/>	€ 12,90 m ² / sqm
	<input type="checkbox"/> dunkelgrau / dark grey	<input type="text"/>	€ 12,90 m ² / sqm
	<input type="checkbox"/> berber / berber	<input type="text"/>	€ 12,90 m ² / sqm
	<input type="checkbox"/> schwarz / black	<input type="text"/>	€ 12,90 m ² / sqm
	Folienabdeckung / Sheet covering inkl. Verlegung & Entsorgung incl. laying & disposal	<input type="text"/>	€ 2,00 m ² / sqm









Laminatboden / Laminate floor

leihweise, auf Verlegeplatten, inkl. Alukanten / loan for use, laying on shifting plates, incl. alu edges

	<input type="checkbox"/> Nuss / walnut	<input type="text"/>	€ 36,00 m ² / sqm
	<input type="checkbox"/> Eiche / oak	<input type="text"/>	€ 36,00 m ² / sqm
	<input type="checkbox"/> Ahorn / Maple	<input type="text"/>	€ 36,00 m ² / sqm
	<input type="checkbox"/> Wenge / Wenge	<input type="text"/>	€ 36,00 m ² / sqm

Bahntenteppich / roll carpet

inkl. Verlegung u. Folienabdeckung / incl. laying and sheet covering

	<input type="checkbox"/> signalrot / light red	<input type="text"/>	€ 13,30 m ² / sqm
	<input type="checkbox"/> bordeaux / dark red	<input type="text"/>	€ 13,30 m ² / sqm
	<input type="checkbox"/> azur / middle blue	<input type="text"/>	€ 13,30 m ² / sqm
	<input type="checkbox"/> blau / dark blue	<input type="text"/>	€ 13,30 m ² / sqm
	<input type="checkbox"/> hellgrün / light green	<input type="text"/>	€ 13,30 m ² / sqm
	<input type="checkbox"/> flaschengrün / dark green	<input type="text"/>	€ 13,30 m ² / sqm
	<input type="checkbox"/> grau / grey	<input type="text"/>	€ 13,30 m ² / sqm
	<input type="checkbox"/> dunkelgrau / dark grey	<input type="text"/>	€ 13,30 m ² / sqm
	<input type="checkbox"/> schwarz / black	<input type="text"/>	€ 13,30 m ² / sqm

WICHTIG - BESTELFRIST: Bei Bestellungen nach der Bestellfrist muss ein Manipulationszuschlag von 25% verrechnet werden!
IMPORTANT - ORDER DEADLINE: For orders received after the deadline a manipulation surcharge of 25% will be charged!



WICHTIG - BESTELFRIST: Bei Bestellungen nach der Bestellfrist muss ein Manipulationszuschlag von 25% verrechnet werden!
IMPORTANT - ORDER DEADLINE: For orders received after the deadline a manipulation surcharge of 25% will be charged!

Durch seine Unterschrift bestätigt der Auftraggeber unsere allgemeine Geschäftsbedingungen (abgedruckt am Ende dieses technischen Bestellheftes) zur Kenntnis genommen zu haben und deren Inhalt als verbindlich zu akzeptieren. Erfüllungsort und Gerichtsstand ist Wien.
By signing this document the customer acknowledges our general terms and conditions (printed on the last page of this technical order form) as noted and accepts it as binding. Place of jurisdiction is Vienna.

Retour/return to:

Expoxx Messebau GmbH | 1021 Wien | Messeplatz 1
☎ FAX +43 1 72 720 - 6109 ☎ info@expoxx.at

 **DATUM**
DATE

Ort, Datum
Place, date

 **STEMPEL**
STAMP

Firmenstempel und rechtsverbindliche Unterschrift
Stamp and obligatory signature

ICNC, May 7 - 9, 2017

Veranstaltungsname / Name of Event	Halle & Standnr. / Hall & Standno.	Standgröße in m ² / Booth size in sqm
Firmenname / Company's name	Straße / Street	
Postleitzahl / Postal Code	Ort / Place	
Ansprechpartner / Responsible person	E-Mail / E-Mail	
Telefon / Phone	Fax / Fax	UID - Nr. / VAT-No. only for EU countries

Bitte unbedingt ausfüllen! / Please fill out!

Deadline: 30th of March, 2017

These are the technical specifications, which we would kindly ask you to follow:

After you made your decision for a certain graphic option, please ask us for the exact artwork dimension!

The artwork dimension is very individual depending on the booth dimension and on the number of walls you want to brand.

Datenübertragung / data transfer:

 Druckdaten müssen im Format 1:10 eine Auflösung von mindestens 600dpi haben, Schriften müssen vektorisiert, im CMYK Farbraum angelegt und als druckoptimiertes pdf gespeichert sein / *Printing data: uing data has to have a resolution of at least 600 dpi at a the scale 1:10. Convert all fonts into vectorized paths, color sheme should be CMYK, the pdf has to be print optimized.*



Richtlinien für motivzusammenhängende Großformatdrucke / Guidelines for art work printed on several panels:

Bei Grafiken die über mehrere geteilte Flächen gedruckt werden, bitten wir Sie, uns eine Datei mit der gesamten Grafik zu senden. Sollte das aus technischen Gründen nicht möglich sein, bitten wir bei motivzusammenhängenden Großformatdrucke einen Überfüller von 20 mm an allen 4 Seiten jeder Datei mit Schnittmarken außerhalb des Sujets anzulegen / *If your art work is printed on several panels, we kindly ask you to provide one file with one continuing graphic. If this is not possible for technical reasons, please provide the motif contiguous large format artwork with an over filler of 20 mm and crop marks on all 4 sides of each artwork file.*



Farbverbindliche Vorgaben / Colour-use regulations:

Abhängig von Produktion und verwendetem Material können gedruckte Farben variieren. Um sicherzugehen, dass wir Ihren Farbvorstellungen entsprechend drucken, benötigen wir eine farbverbindliche Vorlage (PROOF). Ein PROOF muss immer auf dem selben Medium wie der Druck erstellt werden. Wird das Proof nicht rechtzeitig vor Druck bereitgestellt, sind Reklamationen ausgeschlossen / *Colours can vary due to different materials. To ensure that we are able to print to your satisfaction, please provide a colour proof. A conventional colour copy is not accurate enough. If no representative colour proof (on used material) is provided, no subsequent complaints regarding colour variations can be accepted. If the proof does not reach us in time, there is no reclamation possible.*



Adobe Photoshop CS 6 / Adobe Photoshop CS 6: TIFF und EPS Daten können am besten verarbeitet werden. Dateien müssen im CMYK Modus angelegt werden / *We can process TIFF and EPS data the best. Do not send compressed JPG data. Please set up files in CMYK-Code.*



Adobe Illustrator CS 6 / Adobe Illustrator CS 6: Bitte immer alle Schriften als Vektordaten senden / *Please convert all fonts into vectorized paths.*



Adobe Indesign CS6 / Adobe Indesign CS6: Bitte als druckoptimiertes PDF-File abspeichern / *Please save as print optimized file.*



Adobe Acrobat X Professional / Adobe Acrobat X Professional: Bitte druckoptimiert abspeichern / *We request you to save print data optimized.*



E-Mail: an den zuständigen Projektleiter (Achtung: max. 10 MB / Mail) / *E-Mail has to be send to the project manager (max. 10 MB / E - Mail)*



Upload: Im Falle einer Datei, welche größer ist als 10 MB verwenden Sie bitte diesen Link / in case of bigger than 10 MB - please use this link <https://share.messe.at/filedrop/martin.moser@expoxx.at>



Postweg / post adress: Expoxx Messebau GmbH | Messeplatz 1 | 1021 Wien | z.Hd. des Projektleiters / *attn. to the responsible project manage*

Regiearbeiten für Datenaufbereitung / **labour** for data preparation

per Std./hr. **€ 108,50**

Alle Preise verstehen sich für eine Messedauer bis zu 7 Tagen sowie exkl. MWSt. und 1 % Bestandvertragsgebühr. Preisänderungen bleiben vorbehalten.
All prices are quoted for a period of up to seven days and are quoted exclusive VAT and 1% legal charges. Subject to alteration of prices.



WICHTIG - BESTELLFRIST: Bei Bestellungen nach der Bestellfrist muss ein Manipulationszuschlag von 25% verrechnet werden!
IMPORTANT - ORDER DEADLINE: For orders received after the deadline a manipulation surcharge of 25% will be charged!

Durch seine Unterschrift bestätigt der Auftraggeber unsere allgemeine Geschäftsbedingungen (abgedruckt am Ende dieses technischen Bestellheftes) zur Kenntnis genommen zu haben und deren Inhalt als verbindlich zu akzeptieren. Erfüllungsort und Gerichtsstand ist Wien.

By signing this document the customer acknowledges our general terms and conditions (printed on the last page of this technical order form) as noted and accepts it as binding. Place of jurisdiction is Vienna.

Retour/return to:

Expoxx Messebau GmbH | 1021 Wien | Messeplatz 1
☎ FAX +43 1 72 720 - 6109 ☎ info@expoxx.at

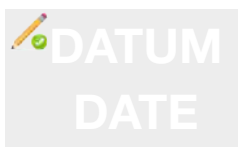

Ort, Datum
Place, date



Firmenstempel und rechtsverbindliche Unterschrift
Stamp and obligatory signature

ICNC, May 7 - 9, 2017

Veranstaltungsname / Name of Event	Halle & Standnr. / Hall & Standno.	Standgröße in m ² / Booth size in sqm
Firmenname / Company's name	Straße / Street	
Postleitzahl / Postal Code	Ort / Place	
Ansprechpartner / Responsible person	E-Mail / E-Mail	
Telefon / Phone	Fax / Fax	UID - Nr. / VAT-No. only for EU countries

Bitte unbedingt ausfüllen! / Please fill out!

Deadline: 30th of March, 2017

Option 1 - graphic on shell scheme wall element

Digital print on shell scheme wall element t = 3 mm, 61,00€/m²

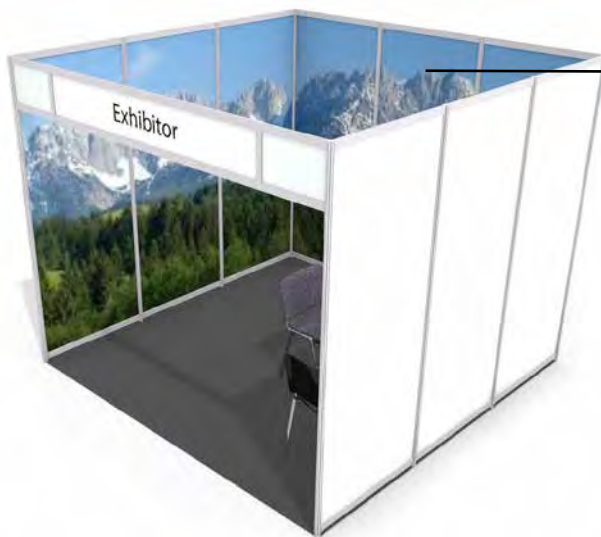

Shell scheme wall element with print,
Shell scheme structure stays visible
Please get in touch with us for the artwork dimension!

One wall element has 2,5 sqm
Visible space W x H / 950 x 2380 mm
(incl. blind W x H / 964 x 2400 mm)
Please ask for the detailed wall measures for graphic-layout plan!

2,5 sqm x 61,00€ = 152,50 €

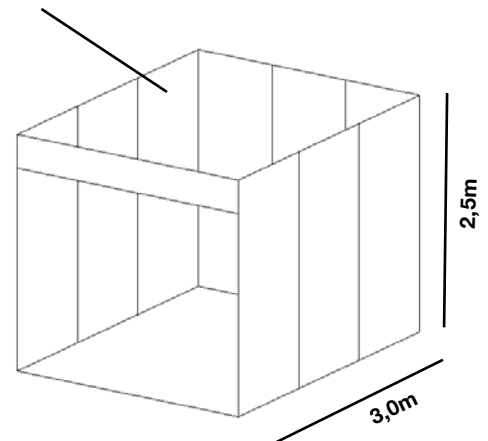

Calculation for a 3 x 3 m booth:

1 wall element 1 x 2,5 m = 2,5 sqm

9 wall elements 9 x 2,5 sqm = 22,5 sqm

22,5 sqm x 61,00€ = 1.372,50€ for branding all 9 shell scheme wall elements

After you made your decision for a certain graphic option, please ask us for the exact artwork dimension!

The artwork dimension is very individual depending on the booth dimension and on the number of walls you want to brand.

We would like to order sqm graphic print on wall panel

Alle Preise verstehen sich für eine Messedauer bis zu 7 Tagen sowie exkl. MWSt. und 1 % Bestandvertragsgebühr. Preisänderungen bleiben vorbehalten.
All prices are quoted for a period of up to seven days and are quoted exclusive VAT and 1% legal charges. Subject to alteration of prices.



WICHTIG - BESTELLFRIST: Bei Bestellungen nach der Bestellfrist muss ein Manipulationszuschlag von 25% verrechnet werden!
IMPORTANT - ORDER DEADLINE: For orders received after the deadline a manipulation surcharge of 25% will be charged!

Durch seine Unterschrift bestätigt der Auftraggeber unsere allgemeine Geschäftsbedingungen (abgedruckt am Ende dieses technischen Bestellheftes) zur Kenntnis genommen zu haben und deren Inhalt als verbindlich zu akzeptieren. Erfüllungsort und Gerichtsstand ist Wien.

By signing this document the customer acknowledges our general terms and conditions (printed on the last page of this technical order form) as noted and accepts it as binding. Place of jurisdiction is Vienna.

Retour/return to:

Expoxx Messebau GmbH | 1021 Wien | Messeplatz 1
☎ FAX +43 1 72 720 - 6109 ☎ info@expoxx.at

 DATUM
DATE

Ort, Datum
Place, date

 STEMPEL
STAMP

Firmenstempel und rechtsverbindliche Unterschrift
Stamp and obligatory signature

ICNC, May 7 - 9, 2017

Veranstaltungsname / Name of Event	Halle & Standnr. / Hall & Standno.	Standgröße in m ² / Booth size in sqm
Firmenname / Company's name	Straße / Street	
Postleitzahl / Postal Code	Ort / Place	
Ansprechpartner / Responsible person	E-Mail / E-Mail	
Telefon / Phone	Fax / Fax	UID - Nr. / VAT-No. only for EU countries

Bitte unbedingt ausfüllen! / Please fill out!

Deadline: 30th of March, 2017

Option 2 - slimframe graphic digital print slimframe graphic = 88,50/m²
 plus 47,25€ reinforcement per wall



Print of custom graphics on fabric which will be placed in a slimframe.

This frame will be placed against your shell scheme wall.

Shell scheme structure isn't visible at all

Please get in touch with us for the artwork dimension!

One wall element has 7,5 sqm

Please ask for the detailed wall measures for graphic-layout plan!

$7,5 \text{ sqm} \times 88,50\text{€} = 663,75\text{€} + 48,25\text{€} = 712,00\text{€}$

detail fabric holder

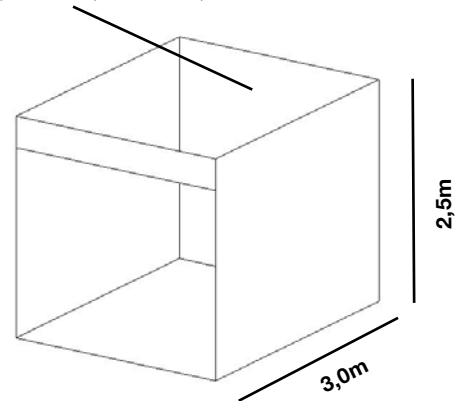

Calculation for a 3 x 3m booth:

1 wall $3 \times 2,5 \text{ m} = 7,5 \text{ sqm}$

$7,5 \text{ sqm} \times 88,50\text{€} = 663,75\text{€}$ slimframe graphic + 48,25€ reinforcement = 712,00€

$712,00\text{€} \times 3 \text{ walls} = 2.136,00\text{€}$ for branding all 3 walls

After you made your decision for a certain graphic option, please ask us for the exact artwork dimension!

The artwork dimension is very individual depending on the booth dimension and on the number of walls you want to brand.

We would like to order sqm slimframe graphic print on fabric material

Alle Preise verstehen sich für eine Messedauer bis zu 7 Tagen sowie exkl. MWSt. und 1 % Bestandsvertragsgebühr. Preisänderungen bleiben vorbehalten.
 All prices are quoted for a period of up to seven days and are quoted exclusive VAT and 1% legal charges. Subject to alteration of prices.

WICHTIG - BESTELLFRIST: Bei Bestellungen nach der Bestellfrist muss ein Manipulationszuschlag von 25% verrechnet werden!
IMPORTANT - ORDER DEADLINE: For orders received after the deadline a manipulation surcharge of 25% will be charged!

Durch seine Unterschrift bestätigt der Auftraggeber unsere allgemeine Geschäftsbedingungen (abgedruckt am Ende dieses technischen Bestellheftes) zur Kenntnis genommen zu haben und deren Inhalt als verbindlich zu akzeptieren. Erfüllungsort und Gerichtsstand ist Wien.

By signing this document the customer acknowledges our general terms and conditions (printed on the last page of this technical order form) as noted and accepts it as binding. Place of jurisdiction is Vienna.

Retour/return to:

Expoxx Messebau GmbH | 1021 Wien | Messeplatz 1
 ☎ FAX +43 1 72 720 - 6109 ☎ info@expoxx.at

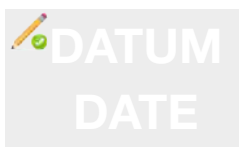

Ort, Datum
 Place, date



Firmenstempel und rechtsverbindliche Unterschrift
 Stamp and obligatory signature

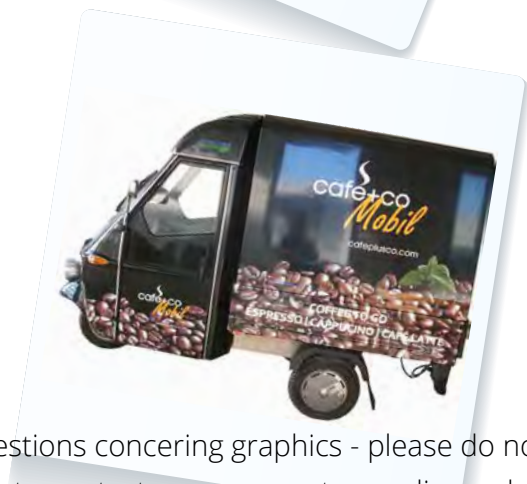

Any questions concerning graphics - please do not hesitate to contact us - we are at your disposal - Wir stehe Ihnen bei allen grafischen Anfragen zur Seite!

Rufen Sie uns an! - Kindly contact us:

☎ +43 1 72 720 - 6101 oder / or

✉ info@expoxx.at

ICNC, May 7 - 9, 2017

Veranstaltungsname / Name of Event	Halle & Standnr. / Hall & Standno.	Standgröße in m ² / Booth size in sqm
Firmenname / Company's name	Straße / Street	
Postleitzahl / Postal Code	Ort / Place	
Ansprechpartner / Responsible person	E-Mail / E-Mail	
Telefon / Phone	Fax / Fax	UID - Nr. / VAT-No. only for EU countries

Bitte unbedingt ausfüllen! / Please fill out!

Deadline: 30th of March, 2017

Ficus / Ficus



€ 44,90

 Stk

bis 150 cm / up to 150 cm

Ficus / Ficus



€ 63,80

 Stk

bis 200 cm / up to 200 cm

Palme / Palm



€ 44,90

 Stk

bis 160 cm / up to 160 cm

Bambus / Bamboo



€ 49,00

 Stk

bis 90 cm / up to 90 cm

Bambus / Bamboo



€ 84,70

 Stk

bis 200 cm / up to 200 cm

Buchs / Buxus Ball, Buxus Pyramide

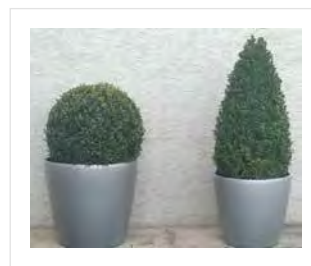

€ 49,00

 Stk

bis 90 cm / up to 90 cm

Alle Preise verstehen sich für eine Messedauer bis zu 7 Tagen sowie exkl. MWST. und 1 % Bestandvertragsgebühr. Preisänderungen bleiben vorbehalten.
 All prices are quoted for a period of up to seven days and are quoted exclusive VAT and 1% legal charges. Subject to alteration of prices.



WICHTIG - BESTELFRIST: Bei Bestellungen nach der Bestellfrist muss ein Manipulationszuschlag von 25% verrechnet werden!
IMPORTANT - ORDER DEADLINE: For orders received after the deadline a manipulation surcharge of 25% will be charged!

Durch seine Unterschrift bestätigt der Auftraggeber unsere allgemeine Geschäftsbedingungen (abgedruckt am Ende dieses technischen Bestellheftes) zur Kenntnis genommen zu haben und deren Inhalt als verbindlich zu akzeptieren. Erfüllungsort und Gerichtsstand ist Wien.

By signing this document the customer acknowledges our general terms and conditions (printed on the last page of this technical order form) as noted and accepts it as binding. Place of jurisdiction is Vienna.

Retour/return to:

Expoxx Messebau GmbH | 1021 Wien | Messeplatz 1
 ☎ FAX +43 1 72 720 - 6109 ☎ info@expoxx.at

DATUM
 DATE

Ort, Datum
 Place, date

STEMPEL
 STAMP

Firmenstempel und rechtsverbindliche Unterschrift
 Stamp and obligatory signature

ICNC, May 7 - 9, 2017

Veranstaltungsname / Name of Event	Halle & Standnr. / Hall & Standno.	Standgröße in m ² / Booth size in sqm
Firmenname / Company's name	Straße / Street	
Postleitzahl / Postal Code	Ort / Place	
Ansprechpartner / Responsible person	E-Mail / E-Mail	
Telefon / Phone	Fax / Fax	UID - Nr. / VAT-No. only for EU countries

Bitte unbedingt ausfüllen! / Please fill out!

Deadline: 30th of March, 2017

Pflanzenwanne / Plant trough



€ 80,50

 Stk

40 x 40 cm

Blumenkiste / Flower pot



€ 61,20

 Stk

bis 100 cm / up to 100 cm

Blumenschale / Flower bowl



€ 32,70

 Stk

Ø 20 cm

Blumenschale / Flower bowl



€ 42,90

 Stk

Ø 25 cm

Blumenschale / Flower bowl



€ 48,00

 Stk

Ø 30 cm

**Schnittblumen
 Flowers**



Auf Anfrage / On request

**Pflanzendekoration
 Floral decoration**



Auf Anfrage / On request

Alle Preise verstehen sich für eine Messedauer bis zu 7 Tagen sowie exkl. MWSt. und 1 % Bestandsvertragsgebühr. Preisänderungen bleiben vorbehalten.
 All prices are quoted for a period of up to seven days and are quoted exclusive VAT and 1% legal charges. Subject to alteration of prices.

WICHTIG - BESTELLFRIST: Bei Bestellungen nach der Bestellfrist muss ein Manipulationszuschlag von 25% verrechnet werden!
IMPORTANT - ORDER DEADLINE: For orders received after the deadline a manipulation surcharge of 25% will be charged!

Durch seine Unterschrift bestätigt der Auftraggeber unsere allgemeine Geschäftsbedingungen (abgedruckt am Ende dieses technischen Bestellheftes) zur Kenntnis genommen zu haben und deren Inhalt als verbindlich zu akzeptieren. Erfüllungsort und Gerichtsstand ist Wien.

By signing this document the customer acknowledges our general terms and conditions (printed on the last page of this technical order form) as noted and accepts it as binding. Place of jurisdiction is Vienna.

Retour/return to:

Expoxx Messebau GmbH | 1021 Wien | Messeplatz 1
 ☎ FAX +43 1 72 720 - 6109 ☎ info@expoxx.at

DATUM
 DATE

Ort, Datum
 Place, date

STEMPEL
 STAMP

Firmenstempel und rechtsverbindliche Unterschrift
 Stamp and obligatory signature

ICNC, May 7 - 9, 2017		
Veranstaltungsname / Name of Event	Halle & Standnr. / Hall & Standno.	Standgröße in m ² / Booth size in sqm
Firmenname / Company's name	Straße / Street	
Postleitzahl / Postal Code	Ort / Place	
Ansprechpartner / Responsible person	E-Mail / E-Mail	
Telefon / Phone	Fax / Fax	UID - Nr. / VAT-No. only for EU countries

Bitte unbedingt ausfüllen! / Please fill out!

Deadline: 30th of March, 2017

OUR BANK DETAILS:

Expoxx Messebau GmbH
UniCredit Bank Austria AG
Account Number: 610663700
Bank Code: 12000
BIC-Code: BKAUATWW
IBAN-Code: AT47 1200 0006 1066 3700
Bank Address: Schottengasse 6 – 8, 1010 Wien, Austria

E-Mails are generally transferred unencrypted – we have installed a secure fax line for you.

Please fill in and return for your security exclusively by fax to: **+43 1 / 72 720 6108**

company:	VAT-No.:	
address:		
postal code:	city:	country:
phone:	fax:	
invoice number:		
card type:		
card number:		
card holder:		
expiry date:		
stamp and signature:		

Orders received after the order deadline until 6 days prior to the event must be paid by **CREDIT CARD OR CASH** and will be subject to 25 % surcharge! **Late orders 5 or less than 5 working days prior to the event must be paid by credit card or cash and will be subject to 50% surcharge.**

!!! Please note !!! Orders are valid only accompanied by full remittance!!!

Alle Preise verstehen sich für eine Messedauer bis zu 7 Tagen sowie exkl. MWST. und 1 % Bestandvertragsgebühr. Preisänderungen bleiben vorbehalten.
 All prices are quoted for a period of up to seven days and are quoted exclusive VAT and 1% legal charges. Subject to alteration of prices.

! WICHTIG - BESTELLFRIST: Bei Bestellungen nach der Bestellfrist muss ein Manipulationszuschlag von 25% verrechnet werden!
IMPORTANT - ORDER DEADLINE: For orders received after the deadline a manipulation surcharge of 25% will be charged!

Durch seine Unterschrift bestätigt der Auftraggeber unsere allgemeine Geschäftsbedingungen (abgedruckt am Ende dieses technischen Bestellheftes) zur Kenntnis genommen zu haben und deren Inhalt als verbindlich zu akzeptieren. Erfüllungsort und Gerichtsstand ist Wien.
 By signing this document the customer acknowledges our general terms and conditions (printed on the last page of this technical order form) as noted and accepts it as binding. Place of jurisdiction is Vienna.

Retour/return to:

Expoxx Messebau GmbH | 1021 Wien | Messeplatz 1
☎ FAX +43 1 72 720 - 6108 ☎ info@expoxx.at

 **DATUM**
DATE

Ort, Datum
Place, date

 **STEMPEL**
STAMP

Firmenstempel und rechtsverbindliche Unterschrift
Stamp and obligatory signature

ICNC, May 7 - 9, 2017

Veranstaltungsname / Name of Event	Halle & Standnr. / Hall & Standno.	Standgröße in m ² / Booth size in sqm
Firmenname / Company's name	Straße / Street	
Postleitzahl / Postal Code	Ort / Place	
Ansprechpartner / Responsible person	E-Mail / E-Mail	
Telefon / Phone	Fax / Fax	UID - Nr. / VAT-No. only for EU countries

Bitte unbedingt ausfüllen! / Please fill out!

Deadline: 30th of March, 2017

Welche Produkte oder Dienstleistungen bieten Sie an?
Which products or services do you offer?

An welchen weiteren Messen beteiligen Sie sich?
On which further fairs do you take part?

Planen Sie einen Erlebnismessestand?
Do you plan an adventure booth?

Planen Sie einen Informations- oder Präsentationsmessestand?
Do you plan an information- or a presentation booth?

Wie hoch ist Ihr Budget für den Standbau und den Messeauftritt?
Which budget do you calculate for booth-build-up and the whole fair?

Was ist der Grund für Ihre Messebeteiligung?
What are your reasons for participation at the fair?

<input type="checkbox"/>	Kundenpflege / customer's service
<input type="checkbox"/>	Imagepflege / imagecare
<input type="checkbox"/>	Markteinführung / launch
<input type="checkbox"/>	Erfahrungsaustausch / exchange of experience
<input type="checkbox"/>	Gewinnung von Neukunden / new customers
<input type="checkbox"/>	Neuheitenpräsentation / presentation of news
<input type="checkbox"/>	Gemeinschaftsstand / community booth
<input type="checkbox"/>	Sonstiges / other

Beispiele für Individualstände / examples for individual booths:



Projekt / Project: Preciosa
Messe / Fair: EuroLuce Mailand
Bereich / Branche: Beleuchtung
Grösse / Size: 320 m²



Projekt / Project: Rettig Austria
Messe / Fair: ISH Frankfurt
Bereich / Branche: Heizung-/Klimatechnik
Grösse / Size: 744 m²



Projekt / Project: Kässbohrer
Messe / Fair: InterAlpin Innsbruck
Bereich / Branche: Alpine Technologien
Grösse / Size: 1.039 m²

 **DATUM**
DATE

Ort, Datum
Place, date

 **STEMPEL**
STAMP

Firmenstempel und rechtsverbindliche Unterschrift
Stamp and obligatory signature

Retour/return to:

Expoxx Messebau GmbH | 1021 Wien | Messeplatz 1
☎ FAX +43 1 72 720 - 6109 ☎ info@expoxx.at

ALLGEMEINE GESCHÄFTSBEDINGUNGEN („AGB“) DER EXPOXX MESSEBAU GMBH („Expoxx Messebau“)

I. ALLGEMEINER TEIL

- Anbot/Vertragsverhältnis:** Für sämtliche Vertragsverhältnisse zwischen Expoxx Messebau und Auftraggebern (nachstehend „Kunden“) kommen ausschließlich diese AGB zur Anwendung. Entgegenstehende oder abweichende Bedingungen von Kunden gelten nur soweit Expoxx Messebau diesen ausdrücklich schriftlich zugestimmt hat. Bei Miete oder Kauf gelten zusätzlich die besonderen Bestimmungen des II. und III. Abschnittes. Die Bestellung des Kunden ist für diesen verbindlich und nicht widerruflich. Sie kann von Expoxx Messebau binnen 30 Tagen durch Erfüllung oder durch Übersendung einer schriftlichen Bestätigung oder einer Akontorechnung gemäß Punkt 13. angenommen werden. Hat der Kunde eine Lieferung zu einer bestimmten Messe bestellt und ist der Auftrag bis 1 Woche vor Veranstaltungsbeginn von Expoxx Messebau nicht angenommen worden, so hat der Kunde dies Expoxx Messebau unverzüglich mitzuteilen. Eine Verpflichtung von Expoxx Messebau, die Bestellung des Kunden anzunehmen besteht nicht. Anbote der Expoxx Messebau an den Kunden sind unverbindlich und freibleibend.
- Mitwirkung des Kunden:** Mit der Bestellung verpflichtet sich der Kunde auch, die für die ordnungsgemäße Ausführung der Bestellung nötigen Unterlagen (etwa Pläne, Modelle, Genehmigungen, Richtlinien für die Ausführung etc.) gemäß den Terminvorgaben von Expoxx Messebau zeitgerecht zur Verfügung zu stellen. Diese Unterlagen müssen so beschaffen sein, dass eine einwandfreie Ausführung der Bestellung gewährleistet ist. Insbesondere hat der Kunde für die Ausführung der Bestellung erforderlichen Genehmigungen auf seine Kosten Sorge zu tragen. Ausführungs- und Materialmuster, die Expoxx Messebau dem Kunden zur Begutachtung vorlegt, müssen von diesem fristgerecht schriftlich bestätigt und retourniert werden; Andernfalls gelten sie als „ohne Korrektur“ genehmigt.
- Leistungsumfang:** Sofern nicht anders angegeben, schuldet Expoxx Messebau dem Kunden nur die Lieferung der bestellten Gegenstände an den Ort der Übergabe. Montageleistungen und andere zusätzliche Leistungen muss der Kunde mit Expoxx Messebau gesondert vereinbaren.
- Ort der Übergabe:** Der Ort der Übergabe ist grundsätzlich die vom Kunden in der Bestellung angegebene Lieferadresse. Bestellt der Kunde eine Lieferung zu einer bestimmten Messe, so ist Ort der Übergabe der vom Kunden angegebene Stand in der vom Kunden bezeichneten Halle am Ort der betreffenden Messe.
- Zeitpunkt der Lieferung:** Der Zeitpunkt der Lieferung wird grundsätzlich von Expoxx Messebau festgelegt und dem Kunden bekannt gegeben. Nach Möglichkeit wird Expoxx Messebau hierbei Wünschen, die der Kunde in der Bestellung äußert, nachkommen oder sonst ein Einvernehmen mit dem Kunden herstellen. Bestellt der Kunde eine Lieferung zu einer bestimmten Messe, so hat die Lieferung jedenfalls während der vom betreffenden Messeveranstalter in seinen öffentlich zugänglichen allgemeinen Anmeldeunterlagen für Aussteller vorgegebenen Aufbauzeiten zu erfolgen, sofern mit dem Kunden nichts anderes vereinbart wird. Ansonsten muss Expoxx Messebau die Lieferung spätestens 30 Werktagen nach Annahme der Bestellung ausführen.
- Übergabe/Gefahrtragung:** Der Kunde hat dafür Sorge zu tragen, dass er selbst oder eine zur Übernahme der gelieferten Gegenstände befugte Person zum Zeitpunkt der Lieferung am Ort der Übergabe anwesend ist. Ist dies nicht der Fall, ist Expoxx Messebau berechtigt, die an den Kunden zu liefernden Gegenstände am Ort der Lieferung zurückzulassen. Expoxx Messebau ist nicht verpflichtet, die Legitimation der auf dem Stand bei Anlieferung des Mietgutes angetroffenen Personen zu überprüfen. Die von Expoxx Messebau an den Kunden zu liefernden Gegenstände sind übergeben, wenn der Kunde sie unbeanstandet entgegennimmt oder Expoxx Messebau sie – im Falle der Abwesenheit zur Übernahme befugter Personen – zum abgesprochenen Zeitpunkt der Lieferung am Ort der Übergabe zurückklässt. Mit der Übergabe geht die Gefahr des zufälligen Untergangs auf den Kunden über.
- Urheberrechte:** Sämtliche im Zuge der Anboterstellung oder Vertragsdurchführung von Expoxx Messebau oder deren Bediensteten erstellten Unterlagen (insbes. Entwürfe, Pläne und Modelle) bleiben mit allen Rechten Eigentum der Expoxx Messebau und dürfen ohne vorherige Genehmigung weder Dritten zugänglich gemacht, noch veröffentlicht oder vervielfältigt werden. Sie dürfen vom Kunden ausschließlich für den vereinbarten Zweck verwendet werden und sind für den Fall, dass ein Vertragsverhältnis nicht zustande kommt oder wieder storniert wird, unverzüglich an Expoxx Messebau zurück zu stellen.
- Zustimmungserklärung gemäß Datenschutzgesetz:** Der Kunde stimmt der Verwendung der von ihm in der Bestellung bekannt gegebenen Daten („Kundendaten“) durch Expoxx Messebau (DVR Nr. 0577677) sowie der Weitergabe an und Verwendung durch die mit Expoxx Messebau verbundenen Unternehmen System Standbau (DVR Nr. 0807583), Reed Messe Salzburg Gesellschaft m.b.H. (DVR Nr. 0079944), Reed Messe Wien GmbH (DVR Nr. 2108555) und Reed CEE GmbH (DVR Nr. 3003805) (nachstehend „Verbundene Unternehmen“), jeweils zu Zwecken des Marketings und der Werbung für Produkte und Leistungen dieser Unternehmen gegenüber dem Kunden zu. Ein Widerruf ist jederzeit möglich und bewirkt die Unzulässigkeit der weiteren Verwendung der Daten, soweit keine gesetzliche Berechtigung oder Verpflichtung dazu besteht.
- Zustimmungserklärung gemäß Telekommunikationsgesetz:** Der Kunde ist - gegen jederzeitigen Widerruf - damit einverstanden, in Zukunft von Expoxx Messebau und den Verbundenen Unternehmen über Produkte und Leistungen dieser Unternehmen per E-Mail informiert zu werden.
- Werbeerlaubnis:** Der Kunde erteilt weiters seine Zustimmung, dass Expoxx Messebau sowie die Verbundenen Unternehmen die Kundendaten, Firmenwortlaut und Firmenlogo des Kunden, sowie Abbildungen des von Expoxx Messebau oder vom Kunden nach den Plänen von Expoxx Messebau errichteten Standes für eigene Werbezwecke (etwa durch Aufnahme in Referenzlisten, Darstellung im Internet, in Kundenzeitschriften oder in anderen Werbemitteln) verwenden.
- Rücktritt:** Für den Fall, dass (a) der Kunde mit Zahlungen an Expoxx Messebau (aus diesem Auftrag oder anderen Aufträgen) oder mit Zahlungen an Verbundene Unternehmen im Verzug ist, oder (b) ein Insolvenzverfahren gegen ihn eröffnet wurde bzw. droht, hat Expoxx Messebau das Recht, von diesem Vertrag zurückzutreten bzw. ungeachtet der Zahlungsverpflichtung des Kunden die eigene Leistung zurückzubehalten. Im Falle des Rücktritts durch Expoxx Messebau schuldet der Kunde eine Stornogebühr in Höhe des vereinbarten Entgelts.
- Preise:** Sämtliche Preise verstehen sich netto zuzüglich Umsatzsteuer in der jeweiligen gesetzlichen Höhe und zuzüglich aller sonstigen mit Abschluss und Durchführung des Auftrages verbundenen Steuern und Gebühren (z.B. Rechtsgebühren [siehe Punkt 24] oder Werbeabgabe). Die Preisangaben beziehen sich auf Lieferungen und Leistungen im Messezentrum Wien und Salzburg, die Verkaufspreise gelten ab Lager Wien. Bei anderen Leistungsarten werden Spesen, Diäten, Bearbeitungs- und Transportkosten separat verrechnet. Zusätzliche, nicht im Anbot enthaltene Leistungen, werden nach tatsächlichem Aufwand in Rechnung gestellt.
- Zahlungsbedingungen:** Expoxx Messebau hat das Recht, dem Kunden nach Erhalt der Bestellung eine Akontozahlung in Höhe von 50% des Auftragswertes in Rechnung zu stellen. Bei Kunden, die ihren Wohnsitz im Ausland haben, bei Neukunden oder bei Kunden, die bei früheren Bestellungen bereits mit Zahlungen im Verzug waren oder bei denen Zweifel an der Bonität bestehen, kann Expoxx Messebau Vorauszahlung von 100% des Auftragswertes verlangen. Lieferungen zu einer bestimmten Messe, die der Kunde erst eine Woche vor oder während der Veranstaltung bei Expoxx Messebau bestellt (maßgeblich ist das Einlangen der Bestellung bei Expoxx Messebau), werden nur gegen Vorauszahlung durchgeführt. Rechnungen sind nach Erhalt netto ohne Abzug zahlbar. Bei Zahlungsverzug schuldet der Kunde Verzugszinsen in Höhe von 12% p.a.. Der Kunde ist nicht berechtigt, wegen Gegenforderungen welcher Art auch immer aufzurechnen oder fällige Zahlungen zu verweigern.
- Tarifänderungen:** Bei Tarifänderungen (etwa Transport-, Versand- oder Energiepreise) erfolgt die Verrechnung auf Basis der jeweils zum Leistungszeitpunkt geltenden Tarife.
- Stornobedingungen:** Die Stornierung bestehender Verträge bzw. der Rücktritt von einer Bestellung ist nur hinsichtlich der für eine bestimmte Messe gemieteten bzw. gekauften Gegenstände zulässig und nur (a) gegen Bezahlung einer Stornogebühr sowie (b) sofern diese Gegenstände nicht von Expoxx Messebau für diesen Auftrag selbst produziert oder von Dritten erworben werden und (c) nur durch schriftliche Erklärung des Kunden, sofern diese bei gemieteten Gegenständen spätestens bis 2 Wochen und bei gekauften Gegenständen spätestens 4 Wochen vor Veranstaltungsbeginn bei Expoxx Messebau einlangt. Bei gemieteten (gekauften) Gegenständen beträgt die Stornogebühr bei Stornierung bis längstens 4 Wochen vor Veranstaltungsbeginn 30% (50%) und bei gemieteten Gegenständen bis längstens 2 Wochen vor Veranstaltungsbeginn 50% des Auftragswertes. Wird die bestellte Ware nicht zum vereinbarten Zeitpunkt abgenommen bleibt der Kunde zur Bezahlung des vollen Preises verpflichtet.
- Schriftlichkeit:** Soweit nach diesen AGB auf die Schriftform abgestellt wird, wird diesem Formerfordernis auch mit Erklärungen (ohne eigenhändige Unterschrift) Genüge getan, die per E-Mail von und an maßgebliche E-Mail-Adressen übermittelt werden. Maßgebliche E-Mail-Adressen im Sinne dieser Bestimmung sind: **16 a.** für den Kunden: jene E-Mail-Adresse, mit der er für den von Expoxx Messebau betriebenen Online-Shop registriert ist, oder die er im Rahmen einer Bestellung (im Bestellformular) angegeben hat. **16 b.** für Expoxx Messebau: die E-Mail-Adresse **info@expoxx.at**.
- Rechtswahl:** Es gilt österreichisches Recht unter Ausschluss der Verweisungsnormen und des UN - Kaufrechts. Erfüllungsort und Gerichtsstand ist Wien.
- Haftungsbeschränkung:** Expoxx Messebau haftet nur für vorsätzlich oder grob fahrlässig verursachte Schäden und beschränkt auf den positiven Schaden.

II. BESONDERE BESTIMMUNGEN FÜR MIETE

- Mietdauer:** Bestellt der Kunde einen Mietgegenstand für eine bestimmte Messe, so entspricht die Mietdauer der Dauer der Messe (inklusive der vom Messeveranstalter für den Aufbau vorgesehenen Zeiten) sofern diese nicht mehr als 7 Tage beträgt. Eine längere Mietdauer muss der Kunde mit Expoxx Messebau jeweils gesondert vereinbaren.
- Verwendung:** Mietgegenstände dürfen ausschließlich für den vereinbarten Zweck verwendet und nicht Dritten überlassen werden. Sie sind unter möglichster Schonung der Substanz zu verwenden und dürfen ohne vorherige Zustimmung von Expoxx Messebau nicht verändert werden. Insbesondere dürfen besondere Kennzeichnungen auf dem Mietgut nicht entfernt und das Mietgut darf nicht beklebt, genagelt, gestrichen oder sonst wie beschädigt werden.
- Haftung und Rückgabe:** Das Mietgut ist unmittelbar nach Veranstaltungsende abholbereit zur Verfügung zu stellen. Gerät der Kunde in Verzug, so ist Expoxx Messebau berechtigt, die Gegenstände auf Kosten und Gefahr des Kunden für den Abtransport vorzubereiten. Das Einverständnis des Kunden wird hierzu vorausgesetzt. Der Kunde haftet verschuldensunabhängig für Verlust oder Beschädigung der Mietgegenstände ab Übergabe bis zur Rückgabe. Bei Beschädigungen oder Verlust ist Expoxx Messebau berechtigt, die fehlenden bzw. beschädigten Gegenstände dem Kunden zum Neupreis in Rechnung zu stellen. Von Expoxx Messebau festgestellte Mängel am rückgelieferten Mietgut werden dem Kunden angezeigt. Die Feststellungen gelten als anerkannt, wenn der Kunde nicht innerhalb einer Woche nach Zugang schriftlich widerspricht.
- Reklamationen / Gewährleistung:** Mietgegenstände werden in der Regel mehrfach verwendet und sind daher nicht neuwertig. Kleinere Abweichungen in der Ausführung, den Maßen und Farben gelten nicht als Mängel. Der Kunde hat bei Übergabe den ordnungsgemäßen Zustand und die Vollständigkeit des Mietgutes zu prüfen. Mit dem Empfang bestätigt der Kunde den mangelfreien Zustand der ihm überlassenen Sachen, es sei denn er erhebt unverzüglich eine schriftliche Mängelrüge. Hat der Kunde zu Recht die Mängelrüge erhoben, so ist die Gewährleistungspflicht von Expoxx Messebau auf Verbesserung beschränkt, soweit es sich bei der mangelhaften Sache um eine bereits gebrauchte handelt.
- Mietpreise / Zuschläge:** Für Lieferungen von Mietgegenständen zu einer bestimmten Messe, die später als 2 Wochen vor Messebeginn bei Expoxx Messebau bestellt werden (maßgeblich ist das Einlangen der Bestellung bei Expoxx Messebau), wird ein Last-Minute Zuschlag von 25% auf die Listenpreise verrechnet. Alle Preise gelten für eine Mietdauer von max. 7 Tagen. Bei einer Mietdauer von bis zu 10 Tagen wird ein Zuschlag von 15% verrechnet. Bei einer Mietdauer von mehr als 10 Tagen werden individuelle Preisvereinbarungen getroffen. Bei verspäteter Rückstellung von Mietgegenständen werden dem Kunden die der Expoxx Messebau durch die Verspätung tatsächlich entstandenen Schäden, mindestens aber 15% des gesamten Auftragswertes in Rechnung gestellt. Wird eine Rechnung von Expoxx Messebau über Wunsch des Kunden neu ausgestellt, etwa im Falle von Änderungen der Rechnungsanschrift oder anderer auf der Rechnung anzuführender Angaben des Kunden, so wird dafür ein pauschales Entgelt von € 70,- exkl. USt. in Rechnung gestellt.
- Vergebührung:** Mietverträge unterliegen einer Rechtsgebühren von 1%. Bemessungsgrundlage ist das Mietentgelt einschließlich Umsatzsteuer sowie des Entgelts für mit der Miete zusammenhängende Leistungen. Die Vergebührung erfolgt durch Expoxx Messebau. Die Rechtsgebühren wird dem Kunden von Expoxx Messebau in Rechnung gestellt. Die Rechtsgebühren ist vom Kunden auch im Falle einer Stornierung zusätzlich zum Stornoentgelt zu bezahlen.

III. BESONDERE BESTIMMUNGEN FÜR VERKAUF

- Eigentumsvorbehalt:** Die gelieferte Ware bleibt bis zur vollständigen Bezahlung des Kaufpreises sowie sämtlicher zum Zeitpunkt der Lieferung bestehender Forderungen Eigentum von Expoxx Messebau. Forderungen aus der Weiterveräußerung der gelieferten Ware tritt der Kunde schon jetzt im Voraus an Expoxx Messebau ab. Der Kunde hat seinen Abnehmern von der Abtretung Mitteilung zu machen und diese aufzufordern, nur noch direkt an Expoxx Messebau Zahlung zu leisten. Ersatzweise ist eine Bankgarantie in der Höhe des Auftragswertes vorzulegen. Die Kosten der Bankgarantie trägt der Kunde.
- Preise bei Drucksachen:** Bei Bestellung von Drucksachen gelten die angegebenen Preise nur bei Bereitstellung von druckfertigen Grafikdaten durch den Kunden. Allfällig erforderliche nachträgliche Druckdatenaufbereitung wird gesondert nach Aufwand in Rechnung gestellt.
- Verpackung und Versand:** Verpackungs- und Versandkosten werden gesondert verrechnet. Expoxx Messebau versendet nur auf Rechnung und auf Gefahr des Kunden. Eine Haftung ist ausgeschlossen. Beschädigungen muss sich der Empfänger sofort bescheinigen lassen und dem Transporteur melden.
- Reklamationen:** Mängel sind vom Kunden bei sonstigem Verlust jeglicher Mängelhaftung innerhalb von 2 Tagen nach Übernahme schriftlich anzuzeigen.

Please find the english version here: www.expoxx.at

GENERAL TERMS AND CONDITIONS ('terms') OF EXPOXX MESSEBAU GMBH (Expoxx Messebau)

I. GENERAL CONDITIONS

- Offers and contractual relationships:** All contractual relations between Expoxx Messebau and clients/customers (hereinafter to be referred to as the 'customer') shall be solely subject to these 'terms'. All other contradictory or deviating conditions mentioned by the customer shall only be accepted on condition they have been explicitly approved by Expoxx Messebau. In cases of hire or purchase the additional conditions in sections II and III shall also apply. Orders Placed by the customer are binding and irrevocable. Expoxx Messebau shall be entitled to accept this order within 30 days by way of provision/completion, or the sending of written confirmation, or by issuing an invoice for part payment according to point 13. If the customer has placed an order for goods/services for a specific trade fair and the order has not been officially confirmed by Expoxx Messebau by 1 week before the beginning of the event, the customer shall be obliged to inform Expoxx Messebau of this fact immediately. There shall be no obligation on the part of Expoxx Messebau to accept an order placed by a customer. Quotes or offers provided by Expoxx Messebau shall be non-binding.
- Customer cooperation:** On order placement the customer shall also become obliged to ensure proper and punctual provision of all documentation according to the dates agreed (i.e. plans, models, permits, and guidelines for execution etc.) that shall be necessary for completion of the order by Expoxx Messebau. This documentation must be provided in such a form as to ensure faultless completion of the order. In particular, the customer shall be responsible for the collection of, and payment for (at his/her own expense), all permits required for the execution of the order. Samples of items and materials provided to the customer by Expoxx Messebau, must be confirmed as accepted in writing and returned within the deadline provided; otherwise they will be considered to have been 'accepted without changes'.
- Scope of services:** If not stated otherwise, Expoxx Messebau shall only be obliged to deliver the items ordered to the place determined for collection. The customer shall be obliged to place a separate order with Expoxx Messebau for assembly/dismantling and other additional services.
- Venue for collection:** As a general principle the venue for collection shall be the address provided in the order for deliveries. If the customer places an order for a delivery to a specific trade fair the venue for collection shall be at the stand in the hall named by the customer at the trade fair in question.
- Time of delivery:** As a general principle the time of delivery shall be determined by Expoxx Messebau and announced to the customer. When possible Expoxx Messebau will take into account wishes stated by the customer in the order; or seek to make an agreement with the customer. If the customer orders a delivery to a specific trade fair the delivery must be conducted during the assembly times provided by the trade fair organiser in the freely and publicly available general registration forms for exhibitors, unless otherwise agreed with the customer. Otherwise, Expoxx Messebau shall be bound to complete service provision within 30 working days after acceptance of the order at the latest.
- Delivery/Transfer of risk:** The customer must ensure that he/she himself/herself, or a person authorised by the customer to the purpose of receiving the goods, is present at the point of delivery at the agreed time of delivery. If this is not the case Expoxx Messebau shall be entitled to leave the goods intended for handover to the customer at the agreed point of delivery. Goods to be delivered by Expoxx Messebau to the customer shall be considered to have been handed over if the customer takes them without complaint or if, at the agreed time and place of delivery, Expoxx Messebau deposits the goods intended for collection by the customer or by his/her authorised representative. Once the goods have been handed over, liability for risks of coincidental damage or destruction of goods shall be transferred to the customer. Expoxx Messebau is not obliged to inspect the accreditation of people present at the stands when the goods for rent are delivered.
- Copyrights:** All documents and drafts produced by Expoxx Messebau or their employees and subcontractors for the purpose of producing an offer or for the purpose of sealing a contractual agreement (particularly drafts, plans and models) remain subject to complete ownership by Expoxx Messebau and may not be made accessible to third parties, published or copied without receiving prior permission from Expoxx Messebau. The customer may only use such documents for the sole purpose agreed. If a contractual relationship does not materialise or is subsequently cancelled, all such documentation must be returned to Expoxx Messebau immediately.
- Declaration of approval according to the data protection law:** The customer approves the right of Expoxx Messebau (DVR no. 0577677) to use information provided in the order (customer details), and approves the forwarding of such information to, and usage by the other related companies affiliated to Expoxx Messebau, such as System Standbau (DVR no. 0807583), Reed Messe Salzburg Gesellschaft m.b.H. (DVR no. 0079944), Reed Messe Wien GmbH (DVR no. 2108555) and Reed CEE GmbH (DVR no. 3003805) (hereinafter 'associated businesses'), each for the purpose of marketing and advertising their own products and services for the customer. Approval can be rescinded at any time rendering any further use of data inadmissible, unless there is a legal entitlement or obligation to do so.
- Declaration of approval according to the telecommunication law:** The exhibitor hereby permits Expoxx Messebau and its associated businesses to inform the exhibitor about their goods and services. The exhibitor is entitled to revoke this permission at any time.
- Permission to advertise:** Furthermore, the customer shall permit Expoxx Messebau and its associated companies to use customer details, company names and corporate logos, as well as pictures of stands erected by, or erected according to plans made by Expoxx Messebau or the customer for Expoxx Messebau's own advertising purposes (such as for addition to reference lists, presentation on the internet, entries in customer magazines or in other forms of advertising).
- Rescission:** If (a) the customer is in arrears with payments to Expoxx Messebau or to any of the other affiliated companies, regardless of whether these debts stem from this or other orders; and/or (b) insolvency proceedings have been initiated against him/her or there is a threat of such proceedings being initiated, Expoxx Messebau shall be entitled to withdraw from the contract and to withhold the provision of services, regardless of the duty of the customer to pay. Should Expoxx Messebau choose to withdraw from the contract the customer shall be liable to pay the agreed cancellation fee.
- Prices:** All prices are quoted net, plus the applicable statutory VAT rate, plus all other taxes, duties and contributions due on placement, acceptance, execution and completion of the order (i.e. legal transaction fees [pt. 24] and advertising duties). Price information pertains to deliveries and services at the exhibition centres in Vienna and Salzburg; sales prices are quoted ex works in Vienna. At other points of service the expenses, allowances, handling and transportation costs may be invoiced separately. Additional services not included in the offer shall be invoiced at the actual price of services and goods used. If Expoxx Messebau revises an existing invoice based on a customer's request, for example to change the billing address or other information on the invoice, this will be subject to a flat fee of € 70,- (plus VAT).
- Conditions of payment:** Expoxx Messebau reserves the right to demand a part payment of 50% of the order value on receipt of the order. If a customer resides in a foreign country, is a new customer or a customer who has previously been late on a payment or whose creditworthiness is not assured, Expoxx Messebau is entitled to demand a full payment of 100% of the order value in advance. Deliveries made to a specific trade fair that the customer only ordered from Expoxx Messebau from a week before the fair up to during the fair itself, (the valid time of receipt being the date upon which Expoxx Messebau officially received the order), will only be completed after a full advance payment. The customer is at no point entitled to set off or withhold due payments against counterclaims of any kind.
- Changes in fees and prices:** Should prices or fees change (i.e. transport, forwarding or energy prices), charges shall be based on the prices and fees valid at the moment of service provision.
- Terms for cancellation:** The cancellation of existing contracts or the revocation of an order shall only be permissible for deliveries made to a specific trade fair and only (a) if a cancellation fee is paid in cash, (b) if the objects in question were not produced by Expoxx Messebau for this specific order or purchased by a third party and (c) only with a written declaration made by the customer, provided it is received by Expoxx Messebau in the case of rented objects at the latest 2 weeks before the trade fair and in the case of purchased objects at the latest 4 weeks before the trade fair begins. In the case of cancellations made at the latest 4 weeks before the event is due to begin for rented (purchased) objects the cancellation fee shall be 30% (50%) of the order value and for rented objects cancelled at the latest 2 weeks before the event is due to begin this fee shall be 50% of the order value. If ordered goods are not received by the customer at the agreed handover time the customer shall nevertheless remain liable for payment of the full price.
- The written form:** Wherever these terms and conditions insist on the use of written communication, this obligation will also be considered to have been fulfilled in the case of declarations made (without a personal signature) that have been sent from and to an authoritative e-mail address. An authoritative e-mail address in compliance with this condition is: **16 a.** for the customer: the e-mail address with which he/she is registered with the online shop run by Expoxx Messebau, or the one that has been given in the course of placing an order (using the order form) and **16 b.** for Expoxx Messebau: the following e-mail address: **info@expoxx.at**.
- Choice of legal basis:** Austrian law shall apply. Legal reference provision norms for international commercial disputes and the United Nations Convention on Contracts for the International Sale of goods shall not apply. Legal venue is Vienna.
- Limited liability:** Expoxx Messebau shall only be held liable for damage caused by deliberate or grossly negligent behaviour and only for positive damage.

II. SPECIAL RENTAL CONDITIONS

- Rental period:** If the customer orders a rentable object for a specific trade fair the rental period shall be for the duration of the trade fair (including the assembly period provided by the fair organiser) as long as the entire period does not exceed 7 days. A longer rental period must be agreed between the customer and Expoxx Messebau in a separate agreement.
- Usage:** Rental objects may be solely used for the agreed purpose and may not be used by third parties. They must be subjected to the least wear, tear and stress as possible and may not be changed without prior receipt of consent from Expoxx Messebau. Special markings on items for rent may under no circumstances be removed by the customer. The customer shall be prohibited from applying any stickers to the said goods, from gluing items to these goods, from attaching items with nails or staples of any type, and from damaging the goods for rent in any way.
- Liability and return of goods:** The rented object must be made available for collection immediately after the event has ended. If there is a delay Expoxx Messebau shall be entitled to prepare the rented objects for collection at the risk and expense of the customer. The consent of the customer shall be a prerequisite in this regard. Regardless of the question of guilt, the customer shall be held liable for loss of, or damage to, rented objects from the point of handover to the point of return. In cases of damage or loss Expoxx Messebau shall be entitled to invoice the customer for the price of brand new replacements for missing or damaged objects. Any faults identified by Expoxx Messebau on returned rented goods will be reported to the customer. These findings shall be considered to have been accepted if the customer does not object in writing within 1 week of receiving this information.
- Complaints / Warranty:** As a general principle rental objects are used on a number of occasions and are thus not classified as being brand new. Small deviations in the versions, dimensions and colours available cannot be categorised as faults. The customer shall be obliged to ensure the rented item(s) is (are) complete and in full working order when it is (they are) handed over to the customer. Receipt of the rented goods by the customer shall signify confirmation of the fault-free condition of the items in his/her possession unless a written complaint specifying defects is submitted immediately. If the customer's complaint is justified, Expoxx Messebau's obligation to honour warranty rights shall be limited to rectification of the fault(s) as regards items that have already been used.
- Rental prices / surcharges:** As regards deliveries of hired objects to a specific trade fair, which have been ordered from Expoxx Messebau later than 2 weeks before the trade fair commences (the valid time of receipt being the date upon which Expoxx Messebau officially received the order), there will be a last-minute surcharge of 25% added to the listed price. All prices are intended for a maximum rental period of 7 days. A surcharge of 15% will be charged for a rental period of up to 10 days. Special agreements shall be made with each individual customer for events lasting more than 10 days. If rental objects are returned late, the customer shall be liable to pay Expoxx Messebau for all actual resultant costs or losses. A minimum of 15% of the full order value shall be charged in such cases.
- Billing:** Rental contracts are subject to a legal fee of 1%. The fee assessment is based on the rental charge including value-added tax, along with compensation for the services associated with the rent. Expoxx Messebau issues the billing. The customer will be invoiced for the legal fee by Expoxx Messebau. The customer is obliged to pay the legal fee even in case of a cancellation in addition to the cancellation fee.

III. SPECIAL SALES CONDITIONS

- Retention of title:** The goods delivered shall remain the property of Expoxx Messebau until the purchase price and all other debts existing at the time of delivery have been paid in full. Any payment gained from the selling-on of any goods delivered shall be forfeited a priori to Expoxx Messebau. The customer shall be obliged to inform his/her customer of this cession and to demand the said customer pay directly to Expoxx Messebau only. Alternatively, a bank guarantee covering the total order value can be accepted in its place. The costs of a bank guarantee shall be borne by the customer.
- Prices of printed materials:** When printed materials have been ordered the prices provided shall only be valid if these materials have been produced using graphics and texts provided in a print-ready form by the customer. All subsequently necessary processing work on print graphics and text will be invoiced separately.
- Packaging and forwarding:** Packaging and forwarding costs are invoiced separately. Expoxx Messebau only delivers on account and at the risk of the customer. No liability shall be accepted on the part of Expoxx Messebau. The recipient must certify all cases of damage immediately and report them to the forwarding agent.
- Complaints:** Any faults, damage or omissions must be reported in writing within 2 days of receipt of goods, otherwise all claims for damages shall be rendered null and void.

Felix	BMW	Audi		Lindner Traktoren	Arbeitsmarkt- Service	Hogast	Reed Exhibitions	
Bundes- ministerium für Unterricht und Kunst	Eternit			dm	Mercedes-Benz		Liebherr expert	
General Motors	Brau Union Österreich AG		HB Austria	eurogast	voran	Julius Meinl		
Salzburg Milch			Makita	Lohberger	Heizomat	Fritz Holter		
Würth		Laska	Doppelmayr					
Emco	Gifas	Österreich Werbung				Salzburg Airport	Steyr Mannlicher	
Schacher- mayer	La Cimbali		Toyota	Austria Center Vienna	Rauch	Schlotterer		
Samsung			Bilton International	Carrera	Kässbohrer	Stiegl Bier		
Österreichische Post AG	Hofer KG	Waterkotte	Miele					
Bose		ISI	Hargasser			Euco	Kotányi	
Trumer Pils	GTM	Tirol Milch	Sparkasse	VW	Wirt- schafts- kammer	AlpenMay Kestag	Rettig Austria	
wohnservice wien	Kolarik & Leeb		Eternit	Caverion		Events & Kongresse		