

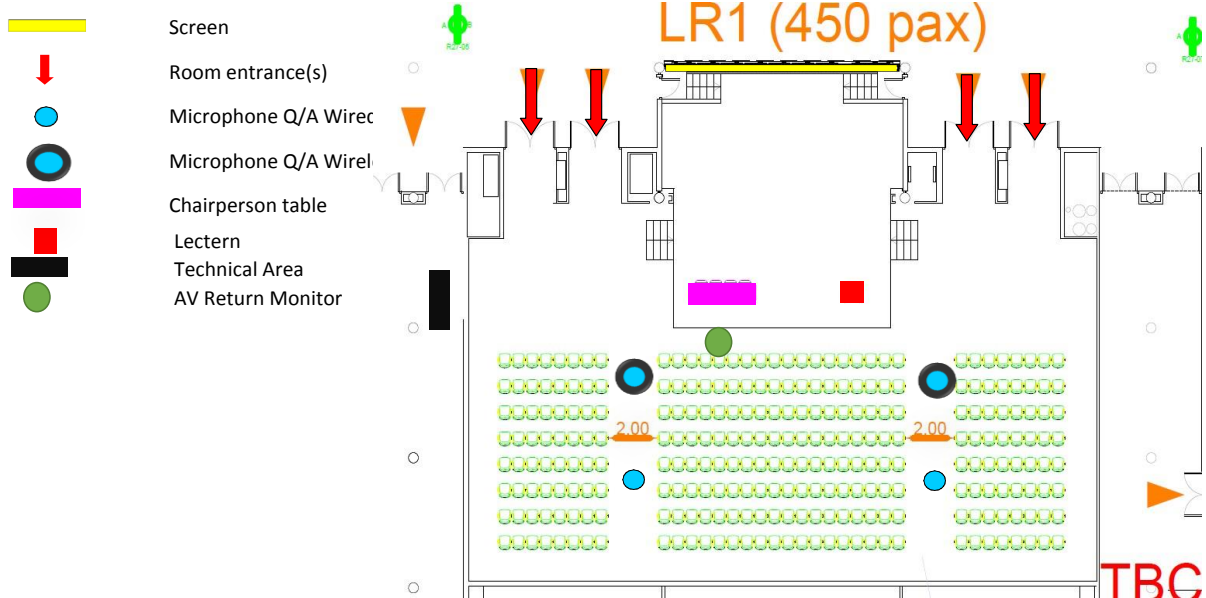







CONGRESS NAME	ESC Preventive 2020, Malaga	
Room Name	Picasso - LR1 - Auditorium 2	
Capacity	450 seats arranged in theatre style	
Stage Size	W: 1100 / D: 400 / H: 20 cm	
For Chairpersons	Table Dimensions	W x D x H : 200 x 80 x 70cm per table
	Standard setup	2 Tables + 4 chairs
	Microphones	2 wired Goose Neck
	Video Monitor	42" on chairperson table x 1
	Camera	NO
For Speaker	Lectern Dimensions	W: 66 / D: 60 / H: 125 cm
	Microphones	2 Wired Goose Neck
	Computer	1 classic laptop Cyim networked with SSC
	Camera	NO
Main Screen	800 x 450	
Projector	12K - 1920*1080	
PinP	NO	
Voting / Ask a question system	NO	
Live sessions enabled	NO	
Audience	2 HAND HELD WIRELESS + 2 HAND HELD WIRED with stands	
External monitor for room programme and overflow	NO	

Lecture Room plan



CONGRESS NAME		ESC Preventive 2020, Malaga
Room Name		Dali - LR2 - Conference rooms 1.1+2+3
Capacity		230 seats arranged in theatre style
Stage Size		W: 600 / D: 200 / H: 40 cm
For Chairpersons	Table Dimensions	W x D x H : 200 x 80 x 70cm per table
	Standard setup	2 Tables + 4 chairs
	Microphones	2 wired Goose Neck
	Video Monitor	42" on chairperson table x 1
For Speaker	Camera	NO
	Lectern Dimensions	W: 66 / D: 60 / H: 125 cm
	Microphones	2 Wired Goose Neck
	Computer	1 classic laptop Cym networked with SSC
	Camera	NO
Main Screen		280 x 180
Projector		10K - 1920*1080
PinP		NO
Voting / Ask a question system		Only Voting
Live sessions enabled		NO
Audience		2 HAND HELD WIRED + 1 HAND HELD WIRELESS with stands
External monitor for room programme and overflow		NO

Lecture Room plan

-  Screen
-  Room entrance(s)
-  Microphone Q/A Wired
-  Microphone Q/A Wireless
-  Chairperson table
-  Lectern
-  Technical Area
-  AV Return Monitor

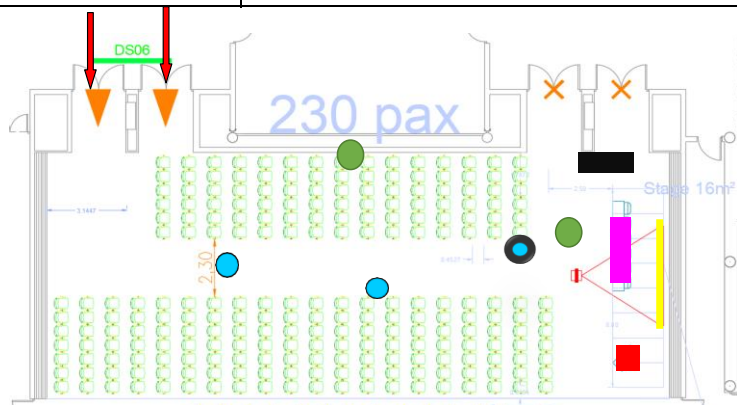

CONGRESS NAME		ESC Preventive 2020, Malaga
Room Name		Goya - LR3 - Conference rooms 1.4+5+6
Capacity		170 seats arranged in theatre style
Stage Size		W: 600 / D: 200 / H: 40 cm
For Chairpersons	Table Dimensions	W x D x H : 200 x 80 x 70cm per table
	Standard setup	2 Tables + 4 chairs
	Microphones	2 wired Goose Neck
	Video Monitor	42" on chairperson table x 1
	Camera	NO
For Speaker	Lectern Dimensions	W: 66 / D: 60 / H: 125 cm
	Microphones	2 Wired Goose Neck
	Computer	1 classic laptop Cyim networked with SSC
	Camera	NO
Main Screen		280 x 180
Projector		10K - 1920 x 1080
PinP		NO
Voting / Ask a question system		NO
Live sessions enabled		NO
Audience		1 HAND HELD WIRED +1 WIRELESS HANDHELD with stands
External monitor for room programme and overflow		NO

Lecture Room plan

- Screen
- Room entrance(s)
- Microphone Q/A Wired
- Microphone Q/A Wireless
- Chairperson table
- Lectern
- Technical Area
- AV Return Monitor

