





<b>CONGRESS NAME</b>	<b>Acute CVD 2019, Malaga</b>	
<b>Room Name</b>	<b>LR1 - Auditorium 2</b>	
<b>Capacity</b>	450 seats arranged in theatre style	
<b>Stage Size</b>	W: 1100 / D: 400 / H: 20 cm	
<b>For Chairpersons</b>	Table Dimensions	W x D x H : 200 x 80 x 70cm (front sign: 200 x h. 70 cm)
	Standard setup	2 Tables + 4 chairs
	Microphones	2 wired Goose Neck
	Video Monitor	55" on chairperson table x 1
	Camera	NO
<b>For Speaker</b>	Lectern Dimensions	W: 66 / D: 60 / H: 125 cm
	Microphones	2 Wired Goose Neck
	Computer	1 classic laptop Cyim networked with SSC
	Camera	NO
<b>Main Screen</b>	800 x 450	
<b>Projector</b>	12K - 1920*1080	
<b>PinP</b>	NO	
<b>Voting / Ask a question system</b>	NO	
<b>Live sessions enabled</b>	NO	
<b>Audience</b>	4 HAND HELD WIRELESS	
<b>External monitor for room programme and overflow</b>	NO	

**Lecture Room plan**

-  Screen
-  Room entrance(s)
-  Microphone Q/A
-  Chairperson table
-  Lectern

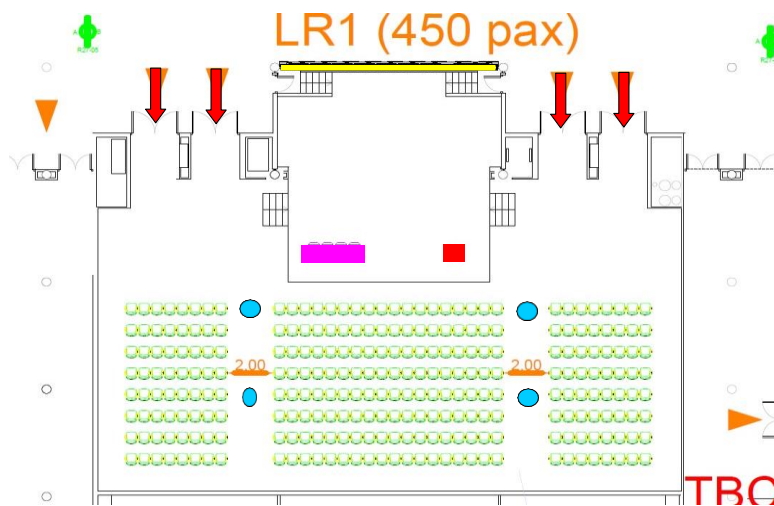

<b>CONGRESS NAME</b>		<b>Acute CVD 2019, Malaga</b>
<b>Room Name</b>		<b>LR2 - Conference Room 1.1+2+3</b>
<b>Capacity</b>		230 seats arranged in theatre style
<b>Stage Size</b>		W: 800 / D: 200 / H: 20 cm
<b>For Chairpersons</b>	Table Dimensions	W x D x H : 200 x 80 x 70cm (front sign: 200 x h. 70 cm)
	Standard setup	2 Tables + 4 chairs
	Microphones	2 wired Goose Neck
	Video Monitor	32" on chairperson table x 1
	Camera	NO
<b>For Speaker</b>	Lectern Dimensions	W: 66 / D: 60 / H: 125 cm
	Microphones	2 Wired Goose Neck
	Computer	1 classic laptop Cym networked with SSC
	Camera	NO
<b>Main Screen</b>		280 x 180
<b>Projector</b>		6,5K - 1280*720 (can receive an HD input 1920 X 1080)
<b>PinP</b>		NO
<b>Voting / Ask a question system</b>		NO
<b>Live sessions enabled</b>		NO
<b>Audience</b>		3 HAND HELD WIRELESS
<b>External monitor for room programme and overflow</b>		NO

**Lecture Room plan**

- Screen
- ↓ Room entrance(s)
- Microphone Q/A
- Chairperson table
- Lectern

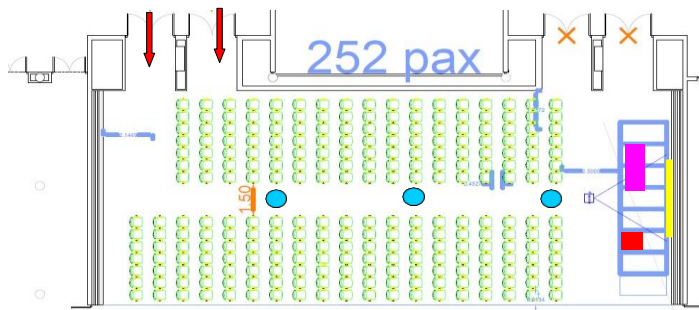



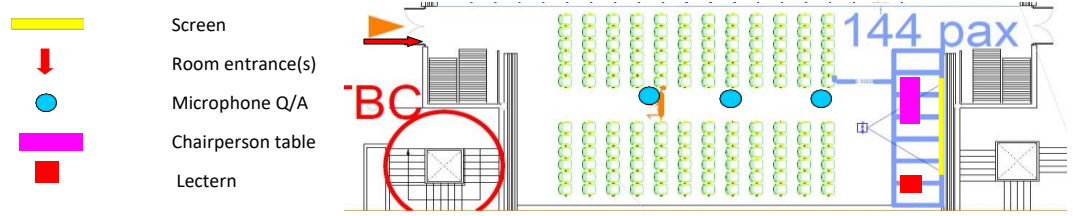

<b>CONGRESS NAME</b>		<b>Acute CVD 2019, Malaga</b>
<b>Room Name</b>		<b>LR3 - Conference Room 1.4+5+6</b>
<b>Capacity</b>		150 seats arranged in theatre style
<b>Stage Size</b>		W: 600 / D: 200 / H: 40 cm
<b>For Chairpersons</b>	Table Dimensions	W x D x H : 200 x 80 x 70cm (front sign: 200 x h. 70 cm)
	Standard setup	2 Tables + 4 chairs
	Microphones	2 wired Goose Neck
	Video Monitor	32" on chairperson table x 1
	Camera	NO
<b>For Speaker</b>	Lectern Dimensions	W: 66 / D: 60 / H: 125 cm
	Microphones	2 Wired Goose Neck
	Computer	1 classic laptop Cym networked with SSC
	Camera	NO
<b>Main Screen</b>		280 x 180
<b>Projector</b>		6,5K - 1280*720 (can receive an HD input 1920 X 1080)
<b>PinP</b>		NO
<b>Voting / Ask a question system</b>		NO
<b>Live sessions enabled</b>		NO
<b>Audience</b>		3 HAND HELD WIRELESS
<b>External monitor for room programme and overflow</b>		NO

**Lecture Room plan**



<b>CONGRESS NAME</b>	<b>Acute CVD 2019, Malaga</b>	
<b>Room Name</b>	<b>LR4 - Multipurpose Room 01</b>	
<b>Capacity</b>	60 seats arranged in theatre style	
<b>Stage Size</b>	W: 600 / D: 200 / H: 40 cm	
<b>For Chairpersons</b>	Table Dimensions	W x D x H : 200 x 80 x 70cm (front sign: 200 x h. 70 cm)
	Standard setup	2 Tables + 4 chairs
	Microphones	2 wired Goose Neck
	Video Monitor	32" on chairperson table x 1
	Camera	NO
<b>For Speaker</b>	Lectern Dimensions	W: 66 / D: 60 / H: 125 cm
	Microphones	2 Wired Goose Neck
	Computer	1 classic laptop Cyim networked with SSC
	Camera	NO
<b>Main Screen</b>	280 x 180	
<b>Projector</b>	5K - 1280*720 (can receive an HD input 1920 X 1080)	
<b>PinP</b>	NO	
<b>Voting / Ask a question system</b>	NO	
<b>Live sessions enabled</b>	NO	
<b>Audience</b>	2 HAND HELD WIRELESS	
<b>External monitor for room programme and overflow</b>	NO	

**Lecture Room plan**

	Screen
	Room entrance(s)
	Microphone Q/A
	Chairperson table
	Lectern

